

宁波亚升铸业有限公司

Ningbo Yasheng Casting Industry Co.Ltd

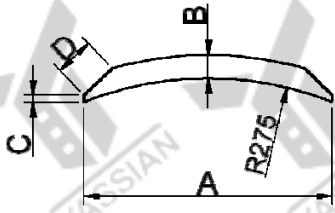

| Double Bevel Curved | | C80: HB300±20 | | 30MnB: HB460±20 | |
|---------------------|-------|---------------|--------|-----------------|---------------|
| SECTION | B mm | A (mm) | C (mm) | D mm | Weight (kg/m) |
| YSDBC-152-13 | 13.00 | 152.00 | 2.40 | 32.00 | 13.30 |
| YSDBC-152-16 | 16.00 | | 2.40 | 32.00 | 16.50 |
| YSDBC-152-19 | 19.00 | | 5.60 | 32.00 | 20.10 |
| YSDBC-203-13 | 13.00 | 203.00 | 2.40 | 32.00 | 19.00 |
| YSDBC-203-16 | 16.00 | | 2.40 | 32.00 | 23.40 |
| YSDBC-203-19 | 19.00 | | 5.60 | 32.00 | 28.20 |
| YSDBC-203-25 | 25.00 | | 11.90 | 32.00 | 38.00 |

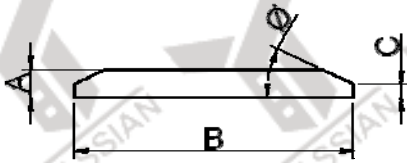

| Double Bevel Flat | | 16Mn: HB350±20 | | 30MnB: HB460±20 | |
|-------------------|-------|----------------|-------|-----------------|---------------|
| SECTION | A mm | B mm | C mm | ∅° | Weight (kg/m) |
| YSDB-152-13 | 13.00 | 152.00 | 3.00 | 25° | 13.80 |
| YSDB-152-16 | 16.00 | | 5.00 | 25° | 17.10 |
| YSDB-152-19 | 19.00 | | 8.00 | 25° | 20.60 |
| YSDB-165-16 | 16.00 | 165.00 | 5.00 | 25° | 18.70 |
| YSDB-203-16 | 16.00 | 203.00 | 4.30 | 25° | 23.20 |
| YSDB-203-19 | 19.00 | | 7.30 | 25° | 28.00 |
| YSDB-203-20 | 20.00 | | 8.30 | 25° | 29.6 |
| YSDB-203-25 | 25.00 | | 13.30 | 25° | 37.50 |
| YSDB-200-20 | 20.00 | 200.00 | 6.00 | 22.5° | 27.8 |
| YSDB-200-35 | 35.00 | | 20.00 | 22.5° | 50.70 |
| YSDB-200-40 | 40.00 | | 25.00 | 22.5° | 58.50 |
| YSDB-230-25 | 25.00 | 230.00 | 13.00 | 25° | 42.70 |

TEL: +86 574 88220258
 FAX: +86 574 88220259
 E-mail: xu@china-yasheng.com

Industrial Park, Hengxi Town Yinzhou, Ningbo, Zhejiang, China
 All the dimensions in this catalog are subject to our final confirmation
 http: //www.yassian.com (以上信息均以我司确认为准) 2014-11-22

宁波亚升铸业有限公司

Ningbo Yasheng Casting Industry Co.Ltd

| Double Bevel Flat | | 16Mn: HB350±20 | | 30MnB: HB460±20 | |
|-------------------|-------|----------------|---------|-----------------|--------|
| SECTION | A mm | B mm | SECTION | A mm | B mm |
| YSDB-250-20 | 20.00 | 250.00 | 6.00 | 25° | 36.00 |
| YSDB-254-19 | 19.00 | 254.00 | 6.00 | 25° | 35.10 |
| YSDB-254-25 | 25.00 | | 12.00 | 25° | 47.00 |
| YSDB-254-30 | 30.00 | | 17.00 | 25° | 57.00 |
| YSDB-254-35 | 35.00 | | 18.00 | 25° | 65.00 |
| YSDB-254-40 | 40.00 | | 23.00 | 25° | 75.00 |
| YSDB-254-45 | 45.00 | | 24.00 | 25° | 82.30 |
| YSDB-265-40 | 40.00 | | 265.00 | 25.00 | 22.5° |
| YSDB-265-45 | 45.00 | 27.00 | | 22.5° | 87.50 |
| YSDB-280-25 | 25.00 | 280.00 | 14.00 | 22.5° | 52.70 |
| YSDB-280-35 | 35.00 | | 18.00 | 22.5° | 71.50 |
| YSDB-305-25 | 25.00 | 305.00 | 9.50 | 22.5° | 55.30 |
| YSDB-305-30 | 30.00 | | 14.00 | 22.5° | 67.00 |
| YSDB-305-35 | 35.00 | | 18.00 | 22.5° | 78.30 |
| YSDB-305-40 | 40.00 | | 22.00 | 22.5° | 89.60 |
| YSDB-330-19 | 19.00 | | 330.00 | 5.00 | 22.5° |
| YSDB-330-25 | 25.00 | 11.00 | | 22.5° | 61.10 |
| YSDB-330-30 | 30.00 | 16.00 | | 22.5° | 74.00 |
| YSDB-330-35 | 35.00 | 21.00 | | 22.5° | 87.00 |
| YSDB-330-40 | 40.00 | 27.00 | | 22.5° | 100.40 |
| YSDB-330-45 | 45.00 | 30.00 | | 22.5° | 112.30 |
| YSDB-330-50 | 50.00 | 32.00 | | 22.5° | 123.40 |
| YSDB-330-60 | 60.00 | 38.00 | 22.5° | 146.30 | |
| YSDB-342-25 | 25.00 | 342.00 | 11.00 | 22.5° | 63.40 |
| YSDB-342-30 | 30.00 | | 16.00 | 22.5° | 76.80 |
| YSDB-360-30 | 30.00 | 360.00 | 8.00 | 22.5° | 75.60 |
| YSDB-360-35 | 35.00 | | 13.00 | 22.5° | 89.70 |
| YSDB-360-45 | 45.00 | | 23.00 | 22.5° | 118.00 |
| YSDB-360-50 | 50.00 | | 28.00 | 22.5° | 132.10 |
| YSDB-406-25 | 25.00 | | 406.00 | 9.00 | 22.5° |

宁波亚升铸业有限公司
Ningbo Yasheng Casting Industry Co.Ltd

| Double Bevel Flat | | 16Mn: HB350±20 | | 30MnB: HB460±20 | |
|-------------------|-------|----------------|---------|-----------------|--------|
| SECTION | A mm | B mm | SECTION | A mm | B mm |
| YSDB-406-30 | 30.00 | 406.00 | 14.00 | 22.5° | 90.80 |
| YSDB-406-35 | 35.00 | | 19.00 | 22.5° | 106.70 |
| YSDB-406-40 | 40.00 | | 25.00 | 22.5° | 123.20 |
| YSDB-406-45 | 45.00 | | 27.00 | 22.5° | 137.30 |
| YSDB-406-50 | 50.00 | | 30.00 | 22.5° | 151.80 |
| YSDB-406-55 | 55.00 | | 34.00 | 22.5° | 166.90 |
| YSDB-406-60 | 60.00 | | 38.00 | 22.5° | 182.10 |
| YSDB-420-45 | 45.00 | 420.00 | 30.00 | 22.5° | 144.10 |
| YSDB-483-30 | 30.00 | 483.00 | 16.00 | 22.5° | 100.00 |
| YSDB-483-35 | 35.00 | | 21.00 | 22.5° | 129.00 |
| YSDB-483-40 | 40.00 | | 27.00 | 22.5° | 148.50 |
| YSDB-483-45 | 45.00 | | 30.00 | 22.5° | 166.40 |
| YSDB-496-30 | 30.00 | 496.00 | 16.00 | 22.5° | 113.10 |
| YSDB-496-35 | 35.00 | | 21.00 | 22.5° | 132.60 |
| YSDB-510-35 | 35.00 | 510.00 | 21.00 | 22.5° | 136.40 |
| YSDB-556-40 | 40.00 | 556.00 | 25.00 | 22.5° | 170.30 |
| YSDB-556-45 | 45.00 | | 27.00 | 22.5° | 190.30 |
| YSDB-556-50 | 50.00 | | 30.00 | 22.5° | 210.70 |
| YSDB-590-40 | 40.00 | 590.00 | 27.00 | 22.5° | 182.10 |
| YSDB-590-50 | 50.00 | | 32.00 | 22.5° | 225.40 |
| YSDB-590-60 | 60.00 | | 38.00 | 22.5° | 268.70 |
| YSDB-660-40 | 40.00 | 660.00 | 27.00 | 22.5° | 204.00 |
| YSDB-660-50 | 50.00 | | 32.00 | 22.5° | 253.90 |
| YSDB-700-50 | 50.00 | 700.00 | 32.00 | 22.5° | 268.60 |

宁波亚升铸业有限公司

Ningbo Yasheng Casting Industry Co.Ltd

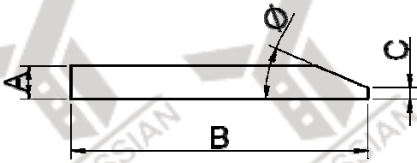

| Single Bevel Flat | | 16Mn: HB350±20 | | 30MnB: HB460±20 | |
|-------------------|--------|----------------|--------|-----------------|---------------|
| SECTION | A (mm) | B (mm) | C (mm) | Ø° | Weight (kg/m) |
| YSSB-110-13 | 13.00 | 110.00 | 3.00 | 24° | 10.30 |
| YSSB-110-16 | 16.00 | | 7.00 | 24° | 13.10 |
| YSSB-150-20 | 20.00 | 150.00 | 8.00 | 24° | 22.28 |
| YSSB-152-13 | 13.00 | 152.00 | 3.00 | 24° | 14.60 |
| YSSB-152-16 | 16.00 | | 5.00 | 24° | 18.00 |
| YSSB-152-19 | 19.00 | | 7.00 | 24° | 21.40 |
| YSSB-200-19 | 19.00 | 200.00 | 6.00 | 23° | 29.83 |
| YSSB-200-20 | 20.00 | | 7.00 | 23° | 37.17 |
| YSSB-200-25 | 25.00 | | 11.00 | 23° | 44.43 |
| YSSB-203-19 | 19.00 | | 203.00 | 6.00 | 23° |
| YSSB-203-20 | 20.00 | 7.00 | | 23° | 30.30 |
| YSSB-203-25 | 25.00 | 11.00 | | 23° | 38.00 |
| YSSB-250-20 | 20.00 | 250 | 6.00 | 22.5° | 37.4 |
| YSSB-250-25 | 25.00 | | 7.00 | 22.5° | 45.7 |
| YSSB-254-19 | 19.00 | 254.00 | 5.00 | 22.5° | 36.30 |
| YSSB-254-20 | 20.00 | | 6.00 | 22.5° | 38.00 |
| YSSB-254-25 | 25.00 | | 7.00 | 22.5° | 46.40 |
| YSSB-254-30 | 30.00 | | 11.00 | 22.5° | 56.40 |
| YSSB-254-35 | 35.00 | | 11.00 | 22.5° | 64.40 |
| YSSB-270-30 | 30.00 | | 270.00 | 10.00 | 23° |
| YSSB-270-35 | 35.00 | 13.00 | | 23° | 69.70 |
| YSSB-290-35 | 35.00 | 290.00 | 13.00 | 23° | 75.20 |
| YSSB-300-25 | 25.00 | 305.00 | 8.00 | 23° | 57.20 |
| YSSB-300-30 | 30.00 | | 8.00 | 23° | 67.40 |
| YSSB-300-35 | 35.00 | | 13.00 | 23° | 79.30 |
| YSSB-300-40 | 40.00 | | 18.00 | 23° | 91.30 |

TEL: +86 574 88220258
 FAX: +86 574 88220259
 E-mail: xu@china-yasheng.com

Industrial Park, Hengxi Town Yinzhou, Ningbo, Zhejiang, China
 All the dimensions in this catalog are subject to our final confirmation
 http: //www.yassian.com (以上信息均以我司确认为准) 2014-11-22

宁波亚升铸业有限公司

Ningbo Yasheng Casting Industry Co.Ltd

| Single Bevel Flat | | 16Mn: HB350±20 | | 30MnB: HB460±20 | |
|-------------------|--------|----------------|---------|-----------------|--------|
| SECTION | A (mm) | B (mm) | SECTION | A (mm) | B (mm) |
| YSSB-300-45 | 45.00 | 305.00 | 18.00 | 23° | 101.00 |
| YSSB-330-25 | 25.00 | | 8.00 | 23° | 62.10 |
| YSSB-330-30 | 30.00 | | 13.00 | 23° | 75.00 |
| YSSB-330-35 | 35.00 | | 13.00 | 23° | 86.20 |
| YSSB-330-40 | 40.00 | | 15.00 | 23° | 97.80 |
| YSSB-330-45 | 45.00 | | 18.00 | 23° | 109.80 |
| YSSB-330-50 | 50.00 | | 20.00 | 23° | 121.20 |
| YSSB-406-35 | 35.00 | 406.00 | 13.00 | 23° | 107.10 |
| YSSB-406-40 | 40.00 | | 15.00 | 23° | 121.70 |
| YSSB-406-45 | 45.00 | | 18.00 | 23° | 136.70 |
| YSSB-406-50 | 50.00 | | 20.00 | 23° | 151.00 |

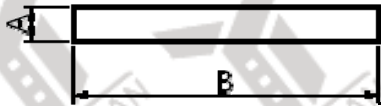

| Wear Bars | 16Mn: HB350±20 | | 30MnB: HB460±20 |
|------------|----------------|--------|-----------------|
| SECTION | A mm | B mm | Weight (kg/m) |
| YSF-120-13 | 13.00 | 120.00 | 12.30 |
| YSF-120-16 | 16.00 | | 15.10 |
| YSF-200-19 | 19.00 | | 29.80 |
| YSF-200-20 | 20.00 | 200.00 | 31.40 |
| YSF-200-25 | 25.00 | | 39.30 |
| YSF-200-30 | 30.00 | | 47.10 |
| YSF-200-35 | 35.00 | | 55.00 |
| YSF-250-19 | 19.00 | | 250.00 |
| YSF-250-25 | 25.00 | 49.10 | |
| YSF-250-30 | 30.00 | 58.90 | |
| YSF-250-35 | 35.00 | 68.70 | |
| YSF-250-40 | 40.00 | 78.50 | |

宁波亚升铸业有限公司

Ningbo Yasheng Casting Industry Co.Ltd

| Wear Bars | 16Mn: HB350±20 | 30MnB: HB460±20 | |
|------------|----------------|-----------------|---------------|
| SECTION | A mm | B mm | Weight (kg/m) |
| YSF-280-13 | 13.00 | 280.00 | 28.60 |
| YSF-280-16 | 16.00 | | 35.20 |
| YSF-280-19 | 19.00 | | 41.80 |
| YSF-280-25 | 25.00 | | 55.00 |
| YSF-300-19 | 19.00 | 300.00 | 44.80 |
| YSF-305-25 | 25.00 | 305.00 | 59.90 |
| YSF-305-30 | 30.00 | | 71.80 |
| YSF-330-25 | 25.00 | 330.00 | 64.80 |
| YSF-330-30 | 30.00 | | 77.70 |
| YSF-330-35 | 35.00 | | 90.70 |
| YSF-330-40 | 40.00 | | 103.60 |
| YSF-350-25 | 25.00 | 350.00 | 68.70 |
| YSF-350-30 | 30.00 | | 82.40 |
| YSF-350-35 | 35.00 | | 96.20 |
| YSF-350-40 | 40.00 | | 109.90 |
| YSF-350-45 | 45.00 | 350.00 | 123.60 |
| YSF-350-50 | 50.00 | | 137.40 |
| YSF-360-30 | 30.00 | 360.00 | 84.80 |
| YSF-360-35 | 35.00 | | 98.90 |
| YSF-360-40 | 40.00 | | 113.00 |
| YSF-380-30 | 30.00 | 380.00 | 89.50 |
| YSF-406-25 | 25.00 | 406.00 | 79.70 |
| YSF-406-30 | 30.00 | | 95.60 |
| YSF-406-35 | 35.00 | | 111.60 |
| YSF-406-40 | 40.00 | | 127.50 |
| YSF-406-45 | 45.00 | | 143.40 |
| YSF-406-50 | 50.00 | | 159.40 |

宁波亚升铸业有限公司

Ningbo Yasheng Casting Industry Co.Ltd

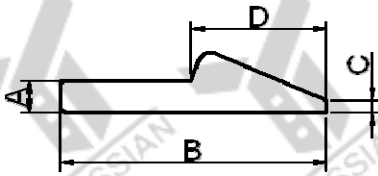

| Half Arrow | | 30MnB: HB460±20 | | | | |
|-------------|-------|-----------------|-------|--------|-------|---------------|
| SECTION | A mm | B mm | C mm | D mm | E mm | Weight (kg/m) |
| YSHA-254-30 | 30.00 | 254.00 | 11.00 | 131.00 | 57.00 | 65.85 |
| YSHA-254-40 | 40.00 | | 25.00 | 131.00 | 70.00 | 85.10 |

宁波亚升铸业有限公司

Ningbo Yasheng Casting Industry Co.Ltd

Double Bevel Curved For Grader

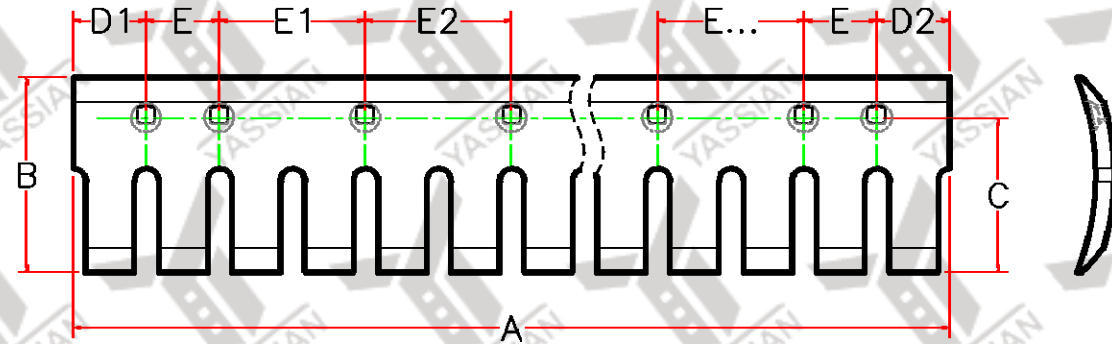
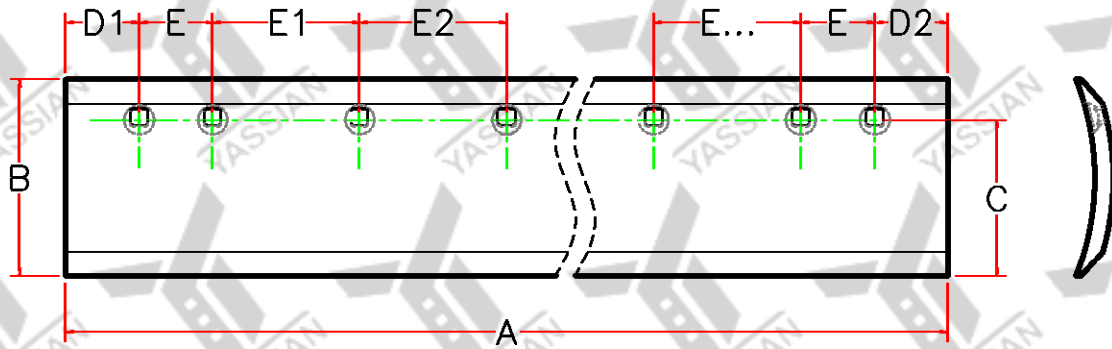

| | | | |
|-------|--|-----------|--|
| MODEL | | BOLT SIZE | |
| PART | | QUANTITY | |

| THICKNESS mm | | | | | | | | | | |
|--------------|----|----|----|--|--|--|--|--|--|--|
| 13 | 16 | 19 | 25 | | | | | | | |
| | | | | | | | | | | |

| A | B | C | D1 | D2 | E | E1 | E2 | E... | | |
|---|---|---|----|----|---|----|----|------|--|--|
| | | | | | | | | | | |

宁波亚升铸业有限公司

Ningbo Yasheng Casting Industry Co.Ltd

Double Bevel Flat For Grader

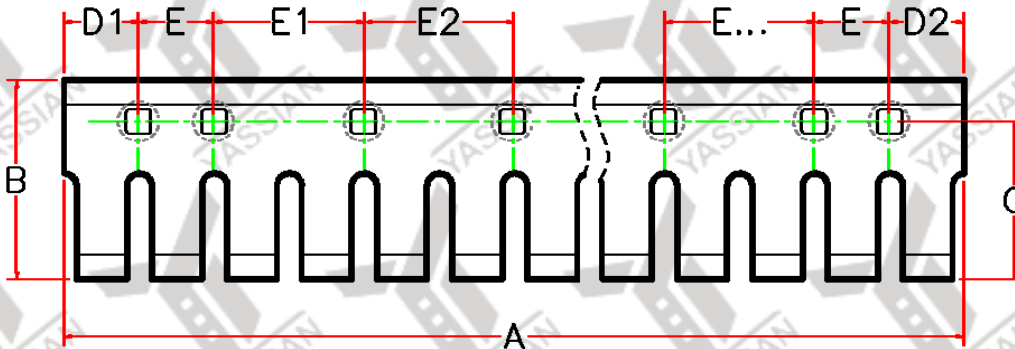
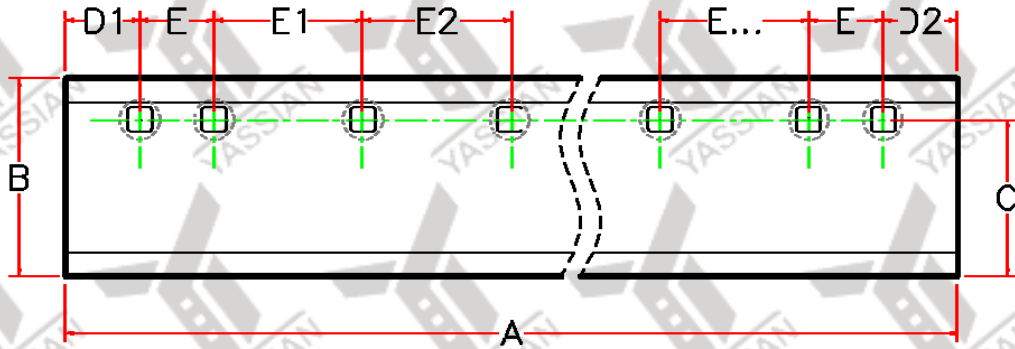

| | | | |
|-------|--|-----------|--|
| MODEL | | BOLT SIZE | |
| PART | | QUANTITY | |

| THICKNESS mm | | | | | | | | | | | |
|--------------|----|----|----|--|--|--|--|--|--|--|--|
| 13 | 16 | 19 | 25 | | | | | | | | |
| | | | | | | | | | | | |

| A | B | C | D1 | D2 | E | E1 | E2 | E... | | |
|---|---|---|----|----|---|----|----|------|--|--|
| | | | | | | | | | | |

宁波亚升铸业有限公司

Ningbo Yasheng Casting Industry Co.Ltd

End Bit For Grader

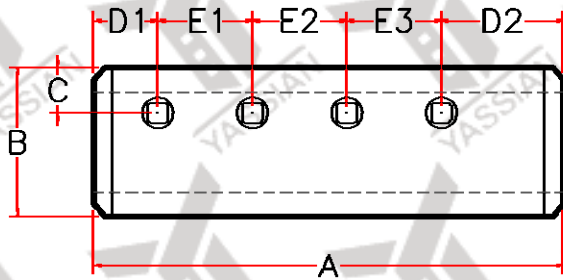

压弯前
before shaping

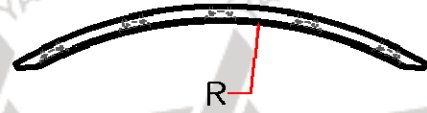

压弯后
after shaping

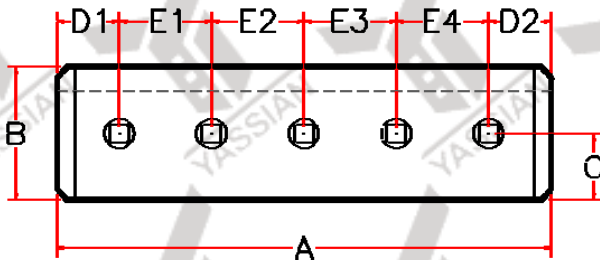

压弯前
before shaping

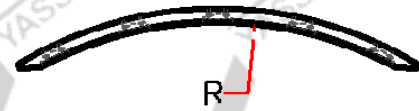

压弯后
after shaping

| | | | |
|-------|--|-----------|--|
| MODEL | | BOLT SIZE | |
| PART | | QUANTITY | |

| THICKNESS mm | | | | | | | | | | | |
|--------------|----|----|----|--|--|--|--|--|--|--|--|
| 13 | 16 | 19 | 25 | | | | | | | | |
| | | | | | | | | | | | |

| | | | | | | | | | | | |
|---|---|---|----|----|---|----|----|----|----|------|--|
| A | B | C | D1 | D2 | R | E1 | E2 | E3 | E4 | E... | |
| | | | | | | | | | | | |

宁波亚升铸业有限公司

Ningbo Yasheng Casting Industry Co.Ltd

End Bit For Grader

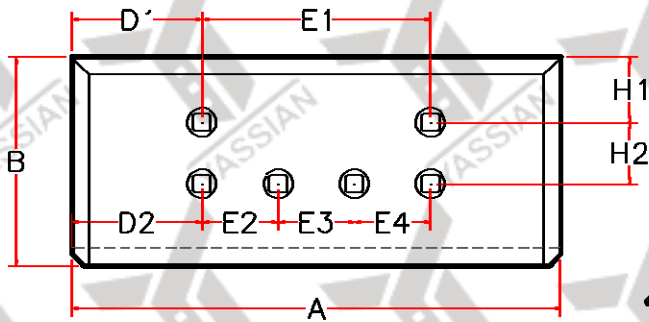

压弯前
before shaping



压弯后
after shaping

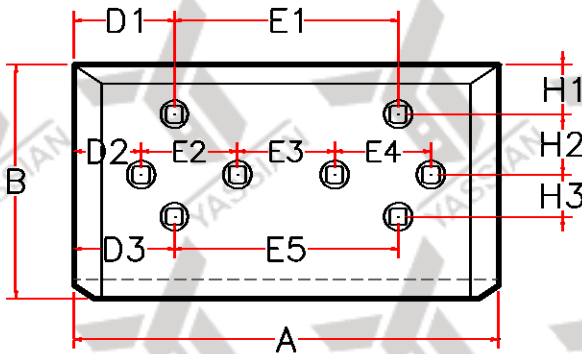

压弯前
before shaping



压弯后
after shaping

| | | | |
|-------|--|-----------|--|
| MODEL | | BOLT SIZE | |
| PART | | QUANTITY | |

| THICKNESS mm | | | | | | | | | | |
|--------------|----|----|----|--|--|--|--|--|--|--|
| 13 | 16 | 19 | 25 | | | | | | | |

| A | B | D1 | D2 | D3 | R | H1 | H2 | H3 | | |
|---|---|----|----|----|---|----|----|----|--|--|
| | | | | | | | | | | |

| E1 | E2 | E3 | E4 | E5 | E... | | | | | |
|----|----|----|----|----|------|--|--|--|--|--|
| | | | | | | | | | | |

宁波亚升铸业有限公司

Ningbo Yasheng Casting Industry Co.Ltd

Double Bevel Flat

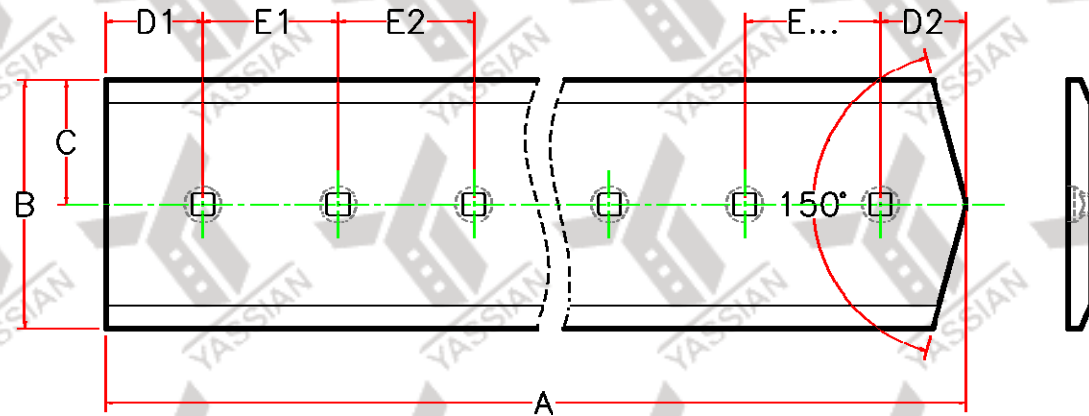
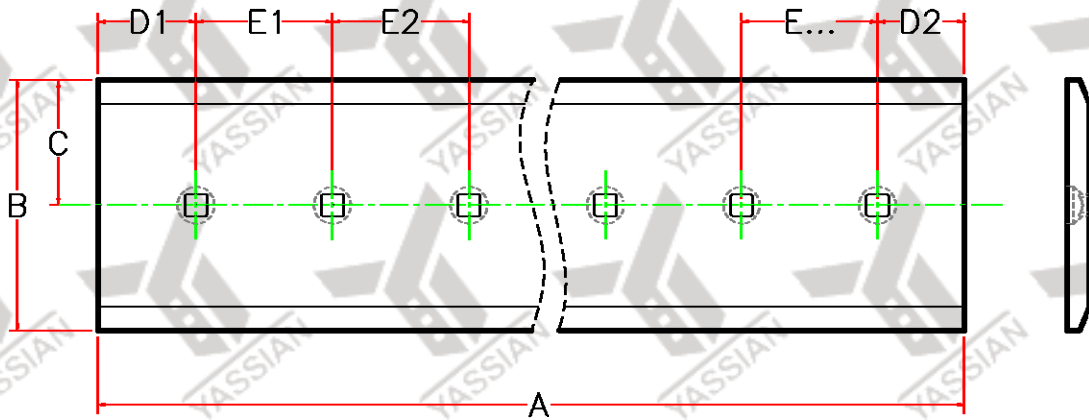

| | | | |
|--------------|--|------------------|--|
| MODEL | | BOLT SIZE | |
| PART | | QUANTITY | |

| THICKNESS mm | | | | | | | | | | | |
|--------------|----|----|----|----|----|----|----|----|----|----|----|
| 15 | 16 | 19 | 25 | 30 | 35 | 40 | 45 | 50 | 55 | 60 | 65 |
| | | | | | | | | | | | |

| A | B | C | D1 | D2 | E1 | E2 | E... | | | | |
|---|---|---|----|----|----|----|------|--|--|--|--|
| | | | | | | | | | | | |

宁波亚升铸业有限公司

Ningbo Yasheng Casting Industry Co.Ltd

Dozer End Bit

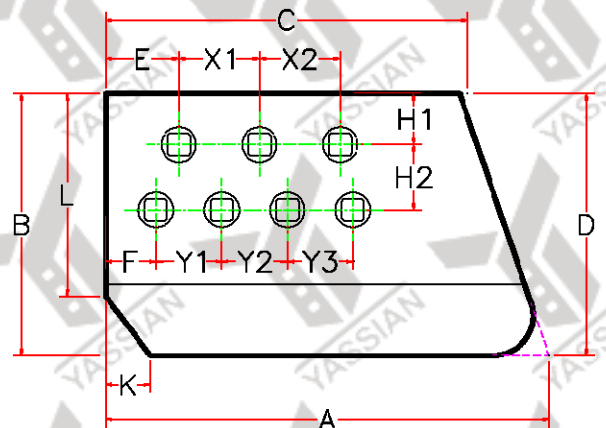
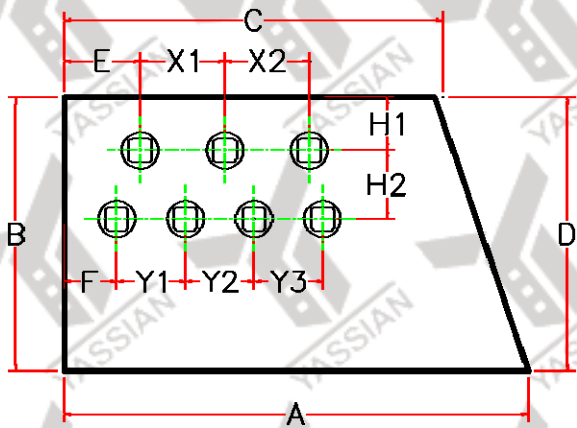
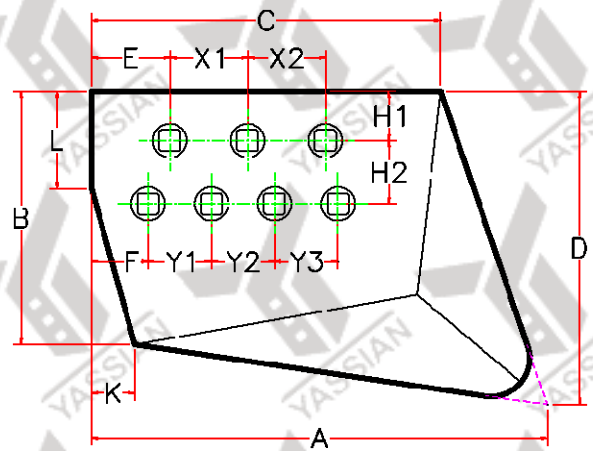
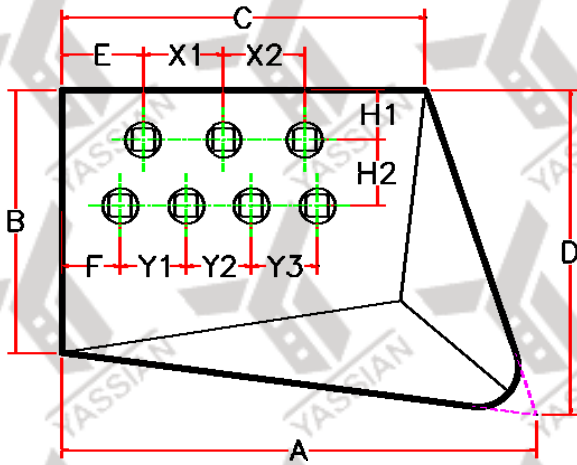

| | | | |
|-------|--|-----------|--|
| MODEL | | BOLT SIZE | |
| PART | | QUANTITY | |

| THICKNESS mm | | | | | | | | | | | |
|--------------|----|----|----|----|----|----|----|----|----|----|----|
| 13 | 16 | 19 | 25 | 30 | 35 | 40 | 45 | 50 | 55 | 60 | 65 |
| | | | | | | | | | | | |

| | | | | | | | | | | | |
|---|---|---|---|---|---|----|----|---|---|--|--|
| A | B | C | D | E | F | H1 | H2 | K | L | | |
| | | | | | | | | | | | |

| | | | | | | | | | | | |
|----|----|----|----|----|--|--|--|--|--|--|--|
| X1 | X2 | Y1 | Y2 | Y3 | | | | | | | |
| | | | | | | | | | | | |

TEL: +86 574 88220258
 FAX: +86 574 88220259
 E-mail: xu@china-yasheng.com

Industrial Park, Hengxi Town Yinzhou, Ningbo, Zhejiang, China
 All the dimensions in this catalog are subject to our final confirmation
<http://www.yassian.com> (以上信息均以我司确认为准) 2014-11-22

宁波亚升铸业有限公司

Ningbo Yasheng Casting Industry Co.Ltd

刀板刀角螺栓孔加工技术标准

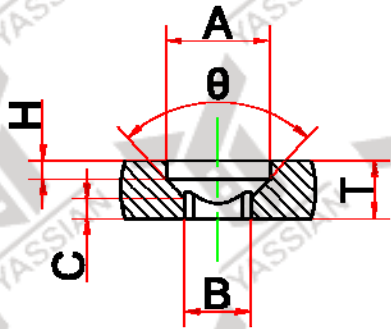

| 钻孔冲孔参数 | 螺栓孔规格 | 钻孔角度 θ° | 钻圆孔尺寸 A(mm) | 冲方孔尺寸 B(mm) | 方孔厚度 C(mm) | 螺栓尺寸 |
|--------|--------|------------------------|----------------|----------------|---------------|-------|
| | 1/2" | 85° ±2° | Φ27 | □15 | 6 | Φ12.7 |
| | 5/8" | | Φ30 | □18 | 6 | Φ15.8 |
| | 3/4" | | Φ34 | □22 | 6 | Φ19 |
| | 7/8" | | Φ41 | □25 | 8 | Φ22.2 |
| | 1" | | Φ44 | □28 | 10 | Φ25.4 |
| | 1-1/4" | | Φ56 | □36 | 12 | Φ31.8 |

宁波亚升铸业有限公司
Ningbo Yasheng Casting Industry Co.Ltd

| DBC Grader Blade | | | | | | | |
|-------------------------|------------------------|----------------------------|---------------------------|-------------------------------|---------------------------|-----------------------------------|-----------------------------|
| PART NO. 型号 | PART NAME 品名 | Length 长 (mm) | Width 宽 (mm) | Thickness 厚 (mm) | No. of Holes 孔数 | Bolt Dia 螺栓尺寸 (inch) | Weight 重量 (kg) |
| 3G8016 9W2293 | Grader Blade | 1219 | 152 | 13 | 9 | 5/8" | 16 |
| 9J3862 9W2295 | Grader Blade | 1524 | 152 | 13 | 11 | 5/8" | 20 |
| 2C3139 | Grader Blade | 1828 | 152 | 13 | 8 | 5/8" | 24 |
| 8D2786 9W2297 | Grader Blade | 1828 | 152 | 13 | 13 | 5/8" | 24 |
| 8D2787 9W2299 | Grader Blade | 2133 | 152 | 13 | 15 | 5/8" | 28 |
| 8J7782 9W2301 | Grader Blade | 2438 | 152 | 13 | 17 | 5/8" | 31.5 |
| 9W2294 | Grader Blade | 1219 | 152 | 13 | 9 | 3/4" | 16 |
| 9W2296 | Grader Blade | 1524 | 152 | 13 | 11 | 3/4" | 20 |
| 9J3660 9W2298 | Grader Blade | 1828 | 152 | 13 | 13 | 3/4" | 24 |
| 9J3659 9W2300 | Grader Blade | 2133 | 152 | 13 | 15 | 3/4" | 28 |
| 9J3656 9W2302 | Grader Blade | 2438 | 152 | 13 | 17 | 3/4" | 31.5 |
| 9W2325 | Grader Blade | 1219 | 152 | 16 | 9 | 5/8" | 20 |
| 5B5567 | Grader Blade | 1524 | 152 | 16 | 7 | 5/8" | 25 |
| 7D4508 7T1640 | Grader Blade | 1524 | 152 | 16 | 11 | 5/8" | 25 |
| 5B5564 | Grader Blade | 1828 | 152 | 16 | 8 | 5/8" | 29 |
| 5D9553 7T1633 | Grader Blade | 1828 | 152 | 16 | 13 | 5/8" | 29 |
| 5B5561 5B5562 | Grader Blade | 2133 | 152 | 16 | 9 | 5/8" | 34 |
| 5D9554 7T1645 | Grader Blade | 2133 | 152 | 16 | 15 | 5/8" | 34 |
| 8J4043 7T1632 | Grader Blade | 2438 | 152 | 16 | 17 | 5/8" | 39 |
| 9W2326 | Grader Blade | 1219 | 152 | 16 | 9 | 3/4" | 20 |
| 9W2327 | Grader Blade | 1524 | 152 | 16 | 11 | 3/4" | 25 |
| 9J3657 7T1637 | Grader Blade | 1828 | 152 | 16 | 13 | 3/4" | 29 |

TEL: +86 574 88220258
FAX: +86 574 88220259
E-mail: xu@china-yasheng.com

Industrial Park, Hengxi Town, Yinzhou, Ningbo, Zhejiang, China
All the dimensions in this catalog are subject to our final confirmation
(以上信息均以我司确认为准) 2014-11-22

http: //www.yassian.com

宁波亚升铸业有限公司
Ningbo Yasheng Casting Industry Co.Ltd

| DBC Grader Blade | | | | | | | |
|-------------------------|------------------------|----------------------------|---------------------------|-------------------------------|---------------------------|-----------------------------------|-----------------------------|
| PART NO. 型号 | PART NAME 品名 | Length 长 (mm) | Width 宽 (mm) | Thickness 厚 (mm) | No. of Holes 孔数 | Bolt Dia 螺栓尺寸 (inch) | Weight 重量 (kg) |
| 9J3658 7T1626 | Grader Blade | 2133 | 152 | 16 | 15 | 3/4" | 34 |
| 9J3655 7T1629 | Grader Blade | 2438 | 152 | 16 | 17 | 3/4" | 39 |
| 3G7966 7T1642 | Grader Blade | 1524 | 152 | 19 | 11 | 5/8" | 30 |
| 5D9556 7T1635 | Grader Blade | 1828 | 152 | 19 | 13 | 5/8" | 35.5 |
| 5D9557 7T1644 | Grader Blade | 2133 | 152 | 19 | 15 | 5/8" | 42 |
| 9W2334 | Grader Blade | 1828 | 152 | 19 | 13 | 3/4" | 35.5 |
| 4Z8785 9W2335 | Grader Blade | 2133 | 152 | 19 | 15 | 3/4" | 42 |
| 9W2309 3G7965 | Grader Blade | 1219 | 203 | 13 | 9 | 5/8" | 23 |
| 9W2311 9J3863 | Grader Blade | 1524 | 203 | 13 | 11 | 5/8" | 28 |
| 9W2313 8D2788 | Grader Blade | 1828 | 203 | 13 | 13 | 5/8" | 34 |
| 9W2315 8D2789 | Grader Blade | 2133 | 203 | 13 | 15 | 5/8" | 40 |
| 9W2317 8J8980 | Grader Blade | 2438 | 203 | 13 | 17 | 5/8" | 45.5 |
| 9W2310 135-6738 | Grader Blade | 1219 | 203 | 13 | 9 | 3/4" | 23 |
| 9W2312 134-1779 | Grader Blade | 1524 | 203 | 13 | 11 | 3/4" | 28 |
| 9W2314 3G1626 | Grader Blade | 1828 | 203 | 13 | 13 | 3/4" | 34 |
| 9W2316 3G1627 | Grader Blade | 2133 | 203 | 13 | 15 | 3/4" | 40 |
| 9W2318 3G1628 | Grader Blade | 2438 | 203 | 13 | 17 | 3/4" | 45.5 |
| 132-1088 9W2328 | Grader Blade | 1219 | 203 | 16 | 9 | 5/8" | 28 |
| 7D4509 7T1641 | Grader Blade | 1524 | 203 | 16 | 11 | 5/8" | 35 |
| 5D9562 7T1636 | Grader Blade | 1828 | 203 | 16 | 13 | 5/8" | 42 |
| 5D9561 7T1643 | Grader Blade | 2133 | 203 | 16 | 15 | 5/8" | 49 |
| 5D9731 7T1631 | Grader Blade | 2438 | 203 | 16 | 17 | 5/8" | 56 |

TEL: +86 574 88220258
FAX: +86 574 88220259
E-mail: xu@china-yasheng.com

Industrial Park,Hengxi Town Yinzhou,Ningbo,Zhejiang,China
All the dimensions in this catalog are subject to our final confirmation
(以上信息均以我司确认为准) 2014-11-22

http: //www.yassian.com

宁波亚升铸业有限公司
Ningbo Yasheng Casting Industry Co.Ltd

| DBC Grader Blade | | | | | | | |
|-------------------------|------------------------|----------------------------|---------------------------|-------------------------------|---------------------------|-----------------------------------|-----------------------------|
| PART NO. 型号 | PART NAME 品名 | Length 长 (mm) | Width 宽 (mm) | Thickness 厚 (mm) | No. of Holes 孔数 | Bolt Dia 螺栓尺寸 (inch) | Weight 重量 (kg) |
| 134-1773 9W2329 | Grader Blade | 1219 | 203 | 16 | 9 | 3/4" | 28 |
| 9W2330 | Grader Blade | 1524 | 203 | 16 | 11 | 3/4" | 35 |
| 9J7701 7T1639 | Grader Blade | 1828 | 203 | 16 | 13 | 3/4" | 42 |
| 7D1158 7T1624 | Grader Blade | 2133 | 203 | 16 | 15 | 3/4" | 49 |
| 8J9821 7T1628 | Grader Blade | 2438 | 203 | 16 | 17 | 3/4" | 56 |
| 132-1087 9W2338 | Grader Blade | 1219 | 203 | 19 | 9 | 5/8" | 33.5 |
| 9W6252 9W2340 | Grader Blade | 1524 | 203 | 19 | 11 | 5/8" | 42 |
| 5D9558 7T1634 | Grader Blade | 1828 | 203 | 19 | 13 | 5/8" | 50 |
| 5D9559 7T1623 | Grader Blade | 2133 | 203 | 19 | 15 | 5/8" | 59 |
| 5D9732 7T1630 | Grader Blade | 2438 | 203 | 19 | 17 | 5/8" | 67 |
| 109-3124 9W2339 | Grader Blade | 1219 | 203 | 19 | 9 | 3/4" | 33.5 |
| 4Z8131 9W2341 | Grader Blade | 1524 | 203 | 19 | 11 | 3/4" | 42 |
| 7D1576 7T1638 | Grader Blade | 1828 | 203 | 19 | 13 | 3/4" | 50 |
| 7D1577 7T1625 | Grader Blade | 2133 | 203 | 19 | 15 | 3/4" | 59 |
| 7D1949 7T1627 | Grader Blade | 2438 | 203 | 19 | 17 | 3/4" | 67 |
| 135-9692 | Grader Blade | 1219 | 203 | 25 | 9 | 5/8" | 45 |
| 4T2240 | Grader Blade | 1524 | 203 | 25 | 11 | 5/8" | 56.5 |
| 4T2244 | Grader Blade | 1828 | 203 | 25 | 13 | 5/8" | 68 |
| 4T2242 | Grader Blade | 2133 | 203 | 25 | 15 | 5/8" | 79 |
| 4T2237 | Grader Blade | 2438 | 203 | 25 | 17 | 5/8" | 90 |
| 109-3150 4T3512 | Grader Blade | 1219 | 203 | 25 | 9 | 3/4" | 45 |
| 4T3511 | Grader Blade | 1524 | 203 | 25 | 11 | 3/4" | 56.5 |

TEL: +86 574 88220258
FAX: +86 574 88220259
E-mail: xu@china-yasheng.com

Industrial Park,Hengxi Town Yinzhou,Ningbo,Zhejiang,China
All the dimensions in this catalog are subject to our final confirmation
(以上信息均以我司确认为准) 2014-11-22

http: //www.yassian.com

宁波亚升铸业有限公司
Ningbo Yasheng Casting Industry Co.Ltd

| DBC Grader Blade | | | | | | | |
|------------------------------|------------------------|----------------------------|---------------------------|-------------------------------|---------------------------|-----------------------------------|-----------------------------|
| PART NO. 型号 | PART NAME 品名 | Length 长 (mm) | Width 宽 (mm) | Thickness 厚 (mm) | No. of Holes 孔数 | Bolt Dia 螺栓尺寸 (inch) | Weight 重量 (kg) |
| 4T2231 | Grader Blade | 1828 | 203 | 25 | 13 | 3/4" | 68 |
| 4T2233 | Grader Blade | 2133 | 203 | 25 | 15 | 3/4" | 79 |
| 4T2236 | Grader Blade | 2438 | 203 | 25 | 17 | 3/4" | 90 |
| 233-70-12141 | Grader Blade | 1524 | 152 | 13 | 7 | 5/8" | 20 |
| 232-70-12140 232-70-12142 | Grader Blade | 1828 | 152 | 13 | 8 | 5/8" | 24 |
| 234-70-12192 | Grader Blade | 2133 | 152 | 13 | 9 | 5/8" | 28 |
| 238-70-12220 | Grader Blade | 1524 | 152 | 16 | 11 | 5/8" | 25 |
| 232-70-12143 | Grader Blade | 1828 | 152 | 16 | 13 | 5/8" | 29 |
| 234-70-12193 | Grader Blade | 2133 | 152 | 16 | 15 | 5/8" | 34 |
| 234-70-12550 | Grader Blade | 2133 | 203 | 16 | 9 | 3/4" | 49 |
| 234-70-12710 | Grader Blade | 2133 | 203 | 16 | 15 | 3/4" | 49 |
| 232-70-52850 | Grader Blade | 1828 | 203 | 19 | 13 | 5/8" | 50 |
| 234-70-12670 | Grader Blade | 2133 | 203 | 19 | 15 | 5/8" | 59 |
| 235-70-12140 | Grader Blade | 2438 | 203 | 19 | 17 | 3/4" | 67 |

TEL: +86 574 88220258
FAX: +86 574 88220259
E-mail: xu@china-yasheng.com

Industrial Park, Hengxi Town, Yinzhou, Ningbo, Zhejiang, China
All the dimensions in this catalog are subject to our final confirmation
(以上信息均以我司确认为准) 2014-11-22
<http://www.yassian.com>

宁波亚升铸业有限公司
Ningbo Yasheng Casting Industry Co.Ltd

| Grader End Bit | | | | | | | |
|-----------------------|------------------------|----------------------------|---------------------------|-------------------------------|---------------------------|---------------------------------|-----------------------------|
| PART NO. 型号 | PART NAME 品名 | Length 长 (mm) | Width 宽 (mm) | Thickness 厚 (mm) | No. of Holes 孔数 | Bolt Dia 螺栓 (inch) | Weight 重量 (kg) |
| 7D9999 | Grader End Bit | 592.7 | 235 | 13 | 8 | 3/4" | 12.8 |
| 6Y2805 | Grader End Bit | 552.9 | 235 | 13 | 8 | 3/4" | 12.1 |
| 8E5529 6Y2801 | Grader End Bit | 462.4 | 152 | 16 | 5 | 3/4" | 7.5 |
| 8E5530 6Y2803 | Grader End Bit | 481.6 | 152 | 19 | 5 | 3/4" | 9.5 |
| 8E5531 | Grader End Bit | 462.4 | 152 | 16 | 5 | 5/8" | 7.5 |
| 7D2052 | Grader End Bit | 464.2 | 152 | 13 | 5 | 5/8" | 6.5 |
| 6D1904 | Grader End Bit | 458.5 | 232 | 13 | 8 | 5/8" | 9.6 |
| 6D1948 | Grader End Bit | 550 | 229 | 13 | 8 | 5/8" | 11.5 |
| 9W1767 | Grader End Bit | 450 | 230 | 13 | 8 | 5/8" | 9.4 |
| 9J4405 | Grader End Bit | 482 | 152 | 16 | 4 | 3/4" | 8.2 |
| 9J4406 | Grader End Bit | 482 | 152 | 16 | 4 | 3/4" | 8.2 |
| 9W1768 | Grader End Bit | 553.7 | 235 | 13 | 8 | 5/8" | 12 |
| 232-70-12150 | Grader End Bit | 420 | 234 | 13 | 5 | 5/8" | 8.4 |
| 232-70-12160 | Grader End Bit | 420 | 234 | 13 | 5 | 5/8" | 8.4 |
| 232-70-52190 | Grader End Bit | 482.5 | 229 | 13 | 6 | 5/8" | 10.5 |
| 234-70-32240 | Grader End Bit | 607.8 | 280 | 13 | 6 | 3/4" | 16 |
| 232-70-52180 | Grader End Bit | 463.6 | 156 | 16 | 5 | 5/8" | 9 |
| 234-70-32230 | Grader End Bit | 500.6 | 203 | 19 | 6 | 3/4" | 14 |
| 232-70-52191 | Grader End Bit | 600 | 229 | 13 | 6 | 5/8" | 13 |
| 234-70-32230 | Grader End Bit | 500.6 | 203 | 19 | 6 | 3/4" | 13.6 |
| U15195 | Grader End Bit | 607 | 279.4 | 13 | 6 | 3/4" | 15.7 |

TEL: +86 574 88220258
FAX: +86 574 88220259
E-mail: xu@china-yasheng.com

Industrial Park, Hengxi Town, Yinzhou, Ningbo, Zhejiang, China
All the dimensions in this catalog are subject to our final confirmation
<http://www.yassian.com> (以上信息均以我司确认为准) 2014-11-22

宁波亚升铸业有限公司
Ningbo Yasheng Casting Industry Co.Ltd

| DBF Cutting Edge | | | | | | | |
|--------------------------|------------------------|----------------------------|---------------------------|-------------------------------|---------------------------|---------------------------------|-----------------------------|
| Part Number 型号 | Part Name 品名 | Length 长 (mm) | Width 宽 (mm) | Thickness 厚 (mm) | No. of Holes 孔数 | Bolt Dia 螺栓 (inch) | Weight 重量 (kg) |
| 107-3523 | > Cutting Edge | 4260 | 406 | 60 | 28 | 1-1/4" | 728.1 |
| 107-3510 | > Cutting Edge | 3721 | 406 | 60 | 22 | 1-1/4" | 355.9 |
| 7T8989 | Cutting Edge | 1518 | 406 | 35 | 10 | 1" | 160.3 |
| 6Y0479 | Cutting Edge | 1353 | 406 | 45 | 9 | 1" | 183.6 |
| 6Y0313 | Cutting Edge | 1353 | 406 | 35 | 9 | 1" | 142.8 |
| 6Y0477 | > Cutting Edge | 1223 | 406 | 45 | 8 | 1" | 164.4 |
| 6Y0478 | > Cutting Edge | 1223 | 406 | 45 | 8 | 1" | 164.4 |
| 6Y0311 | > Cutting Edge | 1223 | 406 | 35 | 8 | 1" | 127.9 |
| 6Y0312 | > Cutting Edge | 1223 | 406 | 35 | 8 | 1" | 127.9 |
| 9W4495 | Cutting Edge | 1098 | 406 | 60 | 9 | 1-1/4" | 192 |
| 9W2426 | Cutting Edge | 1098 | 406 | 45 | 9 | 1-1/4" | 146 |
| 6Y0023 | Cutting Edge | 1064 | 406 | 60 | 9 | 1-1/4" | 186.8 |
| 6Y0018 | Cutting Edge | 1064 | 406 | 45 | 9 | 1-1/4" | 141.2 |
| 6Y0476 | Cutting Edge | 1039 | 406 | 45 | 7 | 1" | 140.9 |
| 7T4342 | Cutting Edge | 1039 | 406 | 40 | 7 | 1" | 126.6 |
| 6Y0310 | Cutting Edge | 1039 | 406 | 35 | 7 | 1" | 109.7 |
| 6Y0021 | Cutting Edge | 1029 | 406 | 60 | 9 | 1-1/4" | 180.3 |
| 6Y0016 | Cutting Edge | 1029 | 406 | 45 | 9 | 1-1/4" | 136.4 |
| 6Y0020 | > Cutting Edge | 1024 | 406 | 60 | 9 | 1-1/4" | 177.6 |
| 6Y0017 | > Cutting Edge | 1024 | 406 | 45 | 9 | 1-1/4" | 134.3 |
| 9W4493 | Cutting Edge | 1023 | 406 | 60 | 9 | 1-1/4" | 177.3 |
| 9W2424 | Cutting Edge | 1023 | 406 | 45 | 9 | 1-1/4" | 135.5 |

TEL: +86 574 88220258
FAX: +86 574 88220259
E-mail: xu@china-yasheng.com

Industrial Park,Hengxi Town Yinzhou,Ningbo,Zhejiang,China
All the dimensions in this catalog are subject to our final confirmation
(以上信息均以我司确认为准) 2014-11-22
<http://www.yassian.com>

宁波亚升铸业有限公司
Ningbo Yasheng Casting Industry Co.Ltd

| DBF Cutting Edge | | | | | | | |
|--------------------------|------------------------|----------------------------|---------------------------|-------------------------------|---------------------------|---------------------------------|-----------------------------|
| Part Number 型号 | Part Name 品名 | Length 长 (mm) | Width 宽 (mm) | Thickness 厚 (mm) | No. of Holes 孔数 | Bolt Dia 螺栓 (inch) | Weight 重量 (kg) |
| 9W4494 | > Cutting Edge | 1020 | 406 | 60 | 9 | 1-1/4" | 175 |
| 9W2425 | > Cutting Edge | 1020 | 406 | 45 | 9 | 1-1/4" | 133.8 |
| 8E2085 | Cutting Edge | 992 | 406 | 60 | 6 | 1-1/4" | 174.7 |
| 9W6656 | Cutting Edge | 992 | 406 | 45 | 6 | 1-1/4" | 132 |
| 9W6609 | Cutting Edge | 992 | 406 | 35 | 6 | 1-1/4" | 103.4 |
| 9W3928 | Cutting Edge | 909 | 406 | 45 | 6 | 1-1/4" | 121.8 |
| 7T9782 | Cutting Edge | 909 | 406 | 35 | 6 | 1-1/4" | 94.9 |
| 7T4341 | Cutting Edge | 900 | 406 | 40 | 6 | 1" | 109.7 |
| 9W3929 | > Cutting Edge | 877 | 406 | 45 | 5 | 1-1/4" | 116.9 |
| 7T9781 | > Cutting Edge | 877 | 406 | 35 | 5 | 1-1/4" | 91.1 |
| 8E2086 | > Cutting Edge | 859 | 406 | 60 | 5 | 1-1/4" | 151.5 |
| 9W6657 | > Cutting Edge | 859 | 406 | 45 | 5 | 1-1/4" | 111 |
| 9W6608 | > Cutting Edge | 859 | 406 | 35 | 5 | 1-1/4" | 87 |
| 8E2087 | Cutting Edge | 850 | 406 | 60 | 5 | 1-1/4" | 151.5 |
| 9W6658 | Cutting Edge | 850 | 406 | 45 | 5 | 1-1/4" | 114 |
| 4T6593 | Cutting Edge | 850 | 406 | 35 | 5 | 1-1/4" | 89.2 |
| 9W6615 | Cutting Edge | 850 | 406 | 35 | 5 | 1-1/4" | 89.2 |
| 9W3930 | > Cutting Edge | 832 | 406 | 45 | 5 | 1-1/4" | 110.8 |
| 7T9779 | > Cutting Edge | 832 | 406 | 35 | 5 | 1-1/4" | 84 |
| 6Y0022 | > Cutting Edge | 783 | 406 | 45 | 7 | 1-1/4" | 102.6 |
| 6Y0019 | > Cutting Edge | 783 | 406 | 45 | 7 | 1-1/4" | 102.6 |
| 9W3931 | Cutting Edge | 757 | 406 | 45 | 5 | 1-1/4" | 101.5 |

TEL: +86 574 88220258
FAX: +86 574 88220259
E-mail: xu@china-yasheng.com

Industrial Park,Hengxi Town Yinzhou,Ningbo,Zhejiang,China
All the dimensions in this catalog are subject to our final confirmation
(以上信息均以我司确认为准) 2014-11-22
<http://www.yassian.com>

宁波亚升铸业有限公司
Ningbo Yasheng Casting Industry Co.Ltd

| DBF Cutting Edge | | | | | | | |
|--------------------------|------------------------|----------------------------|---------------------------|-------------------------------|---------------------------|---------------------------------|-----------------------------|
| Part Number 型号 | Part Name 品名 | Length 长 (mm) | Width 宽 (mm) | Thickness 厚 (mm) | No. of Holes 孔数 | Bolt Dia 螺栓 (inch) | Weight 重量 (kg) |
| 9W0775 | Cutting Edge | 757 | 406 | 35 | 5 | 1-1/4" | 79.1 |
| 6Y0480 | > Cutting Edge | 633 | 406 | 45 | 6 | 1" | 84.2 |
| 6Y0481 | > Cutting Edge | 633 | 406 | 45 | 6 | 1" | 84.2 |
| 6Y0314 | > Cutting Edge | 633 | 406 | 35 | 6 | 1" | 65.6 |
| 6Y0315 | > Cutting Edge | 633 | 406 | 35 | 6 | 1" | 65.6 |
| 107-8586 | Cutting Edge | 620 | 406 | 45 | 4 | 1-1/4" | 83.1 |
| 7T4336 | > Cutting Edge | 589 | 406 | 40 | 4 | 1" | 71 |
| 7T4337 | > Cutting Edge | 589 | 406 | 40 | 4 | 1" | 71 |
| 1U1534 | Cutting Edge | 1575 | 360 | 30 | 10 | 3/4" | 118.5 |
| 1U1537 | Cutting Edge | 1359 | 360 | 30 | 9 | 3/4" | 102.1 |
| 1U1536 | Cutting Edge | 1156 | 360 | 30 | 8 | 3/4" | 86.9 |
| 1U1538 | Cutting Edge | 1054 | 360 | 30 | 7 | 3/4" | 79.2 |
| 4T0840 | Cutting Edge | 3237 | 330 | 40 | 21 | 1" | 320 |
| 9W7044 | Cutting Edge | 2264 | 330 | 45 | 15 | 1" | 249 |
| 7T5701 | Cutting Edge | 2264 | 330 | 35 | 15 | 1" | 193.1 |
| 6Y5538 | Cutting Edge | 2264 | 330 | 30 | 15 | 1" | 164.5 |
| 113-0323 | Cutting Edge | 2164 | 330 | 60 | 14 | 1" | 310.9 |
| 9W3926 | Cutting Edge | 2164 | 330 | 45 | 14 | 1" | 239.2 |
| 9W4397 | Cutting Edge | 2164 | 330 | 35 | 14 | 1" | 185.5 |
| 4T9590 | Cutting Edge | 2164 | 330 | 30 | 14 | 1" | 158 |
| 7J2963 4T2331 | > Cutting Edge | 1974 | 330 | 40 | 13 | 1" | 193.2 |
| 4Z9058 | Cutting Edge | 1953 | 330 | 30 | 13 | 1" | 142.5 |

TEL: +86 574 88220258
FAX: +86 574 88220259
E-mail: xu@china-yasheng.com

Industrial Park, Hengxi Town, Yinzhou, Ningbo, Zhejiang, China
All the dimensions in this catalog are subject to our final confirmation
(以上信息均以我司确认为准) 2014-11-22
<http://www.yassian.com>

宁波亚升铸业有限公司
Ningbo Yasheng Casting Industry Co.Ltd

| DBF Cutting Edge | | | | | | | |
|--------------------------|------------------------|----------------------------|---------------------------|-------------------------------|---------------------------|---------------------------------|-----------------------------|
| Part Number 型号 | Part Name 品名 | Length 长 (mm) | Width 宽 (mm) | Thickness 厚 (mm) | No. of Holes 孔数 | Bolt Dia 螺栓 (inch) | Weight 重量 (kg) |
| 113-0322 | Cutting Edge | 1787 | 330 | 60 | 12 | 1" | 256.4 |
| 9W7043 | Cutting Edge | 1787 | 330 | 45 | 12 | 1" | 195.2 |
| 7T5702 | Cutting Edge | 1787 | 330 | 35 | 12 | 1" | 152.9 |
| 6Y5539 | Cutting Edge | 1787 | 330 | 30 | 12 | 1" | 129.1 |
| 109-3146 | Cutting Edge | 1773 | 330 | 60 | 11 | 7/8" | 255.9 |
| 9W3925 | Cutting Edge | 1694 | 330 | 45 | 11 | 1" | 187.2 |
| 9W4396 4T9836 | Cutting Edge | 1694 | 330 | 35 | 11 | 1" | 144.5 |
| 4T9586 4T9598 | Cutting Edge | 1694 | 330 | 30 | 11 | 1" | 123 |
| 109-9014 | Cutting Edge | 1558 | 330 | 60 | 10 | 7/8" | 224.7 |
| 6Y5777 | Cutting Edge | 1532 | 330 | 40 | 10 | 7/8" | 151.9 |
| 7J2962 4T2324 | Cutting Edge | 1520 | 330 | 40 | 10 | 1" | 150.3 |
| 6Y5776 | Cutting Edge | 1520 | 330 | 40 | 10 | 7/8" | 150.7 |
| 7J2965 4T2325 | Cutting Edge | 1367 | 330 | 40 | 9 | 1" | 135.1 |
| 4T6387 5J6804 | Cutting Edge | 1367 | 330 | 30 | 9 | 1" | 99.8 |
| 112-2472 | Cutting Edge | 1353 | 330 | 45 | 9 | 1" | 149.4 |
| 9W4507 1U1561 | Cutting Edge | 1353 | 330 | 40 | 9 | 1" | 135.8 |
| 7T9126 1U4943 | Cutting Edge | 1353 | 330 | 35 | 9 | 1" | 114.7 |
| 4T6381 3G9264 | Cutting Edge | 1353 | 330 | 30 | 9 | 1" | 97.7 |
| 112-2474 | Cutting Edge | 1240 | 330 | 45 | 8 | 1" | 137.1 |
| 9W9098 | Cutting Edge | 1240 | 330 | 35 | 8 | 1" | 106.4 |
| 9W5432 | Cutting Edge | 1240 | 330 | 30 | 8 | 1" | 90 |
| 9W4508 1U1560 | > Cutting Edge | 1223 | 330 | 40 | 8 | 1" | 119 |

TEL: +86 574 88220258
FAX: +86 574 88220259
E-mail: xu@china-yasheng.com

Industrial Park,Hengxi Town Yinzhou,Ningbo,Zhejiang,China
All the dimensions in this catalog are subject to our final confirmation
(以上信息均以我司确认为准) 2014-11-22
<http://www.yassian.com>

宁波亚升铸业有限公司
Ningbo Yasheng Casting Industry Co.Ltd

| DBF Cutting Edge | | | | | | | |
|--------------------------|------------------------|----------------------------|---------------------------|-------------------------------|---------------------------|---------------------------------|-----------------------------|
| Part Number 型号 | Part Name 品名 | Length 长 (mm) | Width 宽 (mm) | Thickness 厚 (mm) | No. of Holes 孔数 | Bolt Dia 螺栓 (inch) | Weight 重量 (kg) |
| 9W4502 4T2309 | > Cutting Edge | 1223 | 330 | 35 | 8 | 1" | 103.8 |
| 4T6385 3G7762 | > Cutting Edge | 1223 | 330 | 30 | 8 | 1" | 88.4 |
| 9J3751 4T2308 | Cutting Edge | 1218 | 330 | 35 | 8 | 1" | 104.4 |
| 7T4351 | Cutting Edge | 1215 | 330 | 40 | 8 | 1" | 88.7 |
| 4Z8039 | Cutting Edge | 1215 | 330 | 30 | 8 | 1" | 120.1 |
| 128-5695 | Cutting Edge | 1094 | 330 | 60 | 7 | 7/8" | 157.8 |
| 7T4347 | Cutting Edge | 1094 | 330 | 40 | 7 | 1" | 108.2 |
| 123-3754 | Cutting Edge | 1076 | 330 | 60 | 7 | 7/8" | 155.1 |
| 7J2966 4T9554 | Cutting Edge | 1062 | 330 | 40 | 7 | 1" | 104.9 |
| 4T6388 5J6805 | Cutting Edge | 1062 | 330 | 30 | 7 | 1" | 79 |
| 7J2980 4T2334 | Cutting Edge | 1039 | 330 | 40 | 7 | 1" | 102.2 |
| 9W4500 1U4941 | Cutting Edge | 1039 | 330 | 35 | 7 | 1" | 88.3 |
| 4T6386 6J2084 | Cutting Edge | 1039 | 330 | 30 | 7 | 1" | 75.5 |
| 7T4353 | Cutting Edge | 1034 | 330 | 40 | 7 | 1" | 102 |
| 130-7869 | Cutting Edge | 998 | 330 | 60 | 7 | 7/8" | 143.6 |
| 132-1043 | > Cutting Edge | 979 | 330 | 60 | 6 | 7/8" | 140 |
| 132-1042 | > Cutting Edge | 979 | 330 | 60 | 6 | 7/8" | 140 |
| 123-3756 | > Cutting Edge | 974 | 330 | 60 | 6 | 7/8" | 139.2 |
| 123-3755 | > Cutting Edge | 974 | 330 | 60 | 6 | 7/8" | 139.2 |
| 7T4352 | Cutting Edge | 922 | 330 | 40 | 6 | 1" | 91.2 |
| 7T4348 | Cutting Edge | 910 | 330 | 40 | 6 | 7/8" | 90.2 |
| 7J2964 4T2330 | Cutting Edge | 907 | 330 | 40 | 6 | 1" | 89.7 |

TEL: +86 574 88220258
FAX: +86 574 88220259
E-mail: xu@china-yasheng.com

Industrial Park, Hengxi Town Yinzhou, Ningbo, Zhejiang, China
All the dimensions in this catalog are subject to our final confirmation
(以上信息均以我司确认为准) 2014-11-22

http: //www.yassian.com

宁波亚升铸业有限公司
Ningbo Yasheng Casting Industry Co.Ltd

| DBF Cutting Edge | | | | | | | |
|--------------------------|------------------------|----------------------------|---------------------------|-------------------------------|---------------------------|---------------------------------|-----------------------------|
| Part Number 型号 | Part Name 品名 | Length 长 (mm) | Width 宽 (mm) | Thickness 厚 (mm) | No. of Holes 孔数 | Bolt Dia 螺栓 (inch) | Weight 重量 (kg) |
| 112-2475 | Cutting Edge | 900 | 330 | 45 | 6 | 1" | 99.4 |
| 7J2959 4T9558 | Cutting Edge | 900 | 330 | 40 | 6 | 1" | 88 |
| 9W6092 4J8232 | Cutting Edge | 900 | 330 | 35 | 6 | 1" | 77 |
| 4T6378 6J5945 | Cutting Edge | 900 | 330 | 30 | 6 | 1" | 66 |
| 7T5235 | Cutting Edge | 856 | 330 | 40 | 6 | 1" | 94.4 |
| 112-2473 | > Cutting Edge | 824 | 330 | 45 | 5 | 1" | 90.3 |
| 7T9127 | > Cutting Edge | 824 | 330 | 35 | 5 | 1" | 70.1 |
| 9W5232 | > Cutting Edge | 824 | 330 | 30 | 5 | 1" | 59.7 |
| 7T4345 | > Cutting Edge | 810 | 330 | 40 | 5 | 1" | 79.4 |
| 7T4346 | > Cutting Edge | 810 | 330 | 40 | 5 | 1" | 79.4 |
| 112-2471 | > Cutting Edge | 803 | 330 | 45 | 5 | 1" | 88 |
| 7T9125 | > Cutting Edge | 803 | 330 | 35 | 5 | 1" | 67 |
| 6Y5540 4T9587 | > Cutting Edge | 803 | 330 | 30 | 5 | 1" | 57 |
| 113-0321 | > Cutting Edge | 800 | 330 | 60 | 5 | 1" | 113.9 |
| 9W3927 | > Cutting Edge | 800 | 330 | 45 | 5 | 1" | 87 |
| 9W4398 4T9838 | > Cutting Edge | 800 | 330 | 35 | 5 | 1" | 66 |
| 128-5696 | > Cutting Edge | 798 | 330 | 60 | 5 | 7/8" | 114 |
| 128-5697 | > Cutting Edge | 798 | 330 | 60 | 5 | 7/8" | 114 |
| 7T4349 | > Cutting Edge | 780 | 330 | 40 | 5 | 1" | 76.4 |
| 7T4350 | > Cutting Edge | 780 | 330 | 40 | 5 | 1" | 76.4 |
| 109-9095 | Cutting Edge | 776 | 330 | 60 | 5 | 7/8" | 111.9 |
| 109-9096 | Cutting Edge | 776 | 330 | 60 | 5 | 7/8" | 111.9 |

TEL: +86 574 88220258
FAX: +86 574 88220259
E-mail: xu@china-yasheng.com

Industrial Park,Hengxi Town Yinzhou,Ningbo,Zhejiang,China
All the dimensions in this catalog are subject to our final confirmation
(以上信息均以我司确认为准) 2014-11-22
<http://www.yassian.com>

宁波亚升铸业有限公司
Ningbo Yasheng Casting Industry Co.Ltd

| DBF Cutting Edge | | | | | | | |
|--------------------------|------------------------|----------------------------|---------------------------|-------------------------------|---------------------------|---------------------------------|-----------------------------|
| Part Number 型号 | Part Name 品名 | Length 长 (mm) | Width 宽 (mm) | Thickness 厚 (mm) | No. of Holes 孔数 | Bolt Dia 螺栓 (inch) | Weight 重量 (kg) |
| 132-1041 | Cutting Edge | 704 | 330 | 60 | 5 | 7/8" | 101.3 |
| 132-4730 | Cutting Edge | 704 | 330 | 60 | 5 | 7/8" | 101.3 |
| 9W4506 4T2322 | > Cutting Edge | 632 | 330 | 40 | 6 | 1" | 60 |
| 9W4503 4T2307 | > Cutting Edge | 633 | 330 | 35 | 6 | 1" | 53.1 |
| 4T6382 3G9265 | > Cutting Edge | 633 | 330 | 30 | 6 | 1" | 45.3 |
| 7J2979 4T2326 | > Cutting Edge | 589 | 330 | 40 | 4 | 1" | 57.6 |
| 9W9197 | > Cutting Edge | 589 | 330 | 35 | 4 | 1" | 49.9 |
| 4T6377 8J2126 | Cutting Edge | 589 | 330 | 30 | 4 | 1" | 42.9 |
| 4T6379 6J6144 | > Cutting Edge | 589 | 330 | 30 | 4 | 1" | 42.5 |
| 4T6455 | Cutting Edge | 3529 | 305 | 30 | 23 | 1" | 232.6 |
| 4T6450 5J6836 | Cutting Edge | 2209 | 305 | 30 | 15 | 1" | 145.4 |
| 4T6453 5J6893 | > Cutting Edge | 1974 | 305 | 30 | 13 | 1" | 128.8 |
| 4T6448 5J6803 | Cutting Edge | 1520 | 305 | 30 | 10 | 1" | 100.2 |
| 4T6459 5J6806 | Cutting Edge | 1325 | 305 | 30 | 9 | 1" | 87.3 |
| 4T6456 5J6800 | Cutting Edge | 951 | 305 | 30 | 6 | 1" | 62.7 |
| 4T6457 5J6837 | Cutting Edge | 907 | 305 | 30 | 6 | 1" | 59.8 |
| 6Y6763 | Cutting Edge | 1532 | 280 | 35 | 10 | 7/8" | 107.7 |
| 6Y6765 | > Cutting Edge | 1520 | 280 | 35 | 10 | 7/8" | 105.8 |
| 6Y6764 | Cutting Edge | 1520 | 280 | 35 | 10 | 7/8" | 106.9 |
| 9W9793 | > Cutting Edge | 1357 | 280 | 25 | 9 | 7/8" | 69.9 |
| 9W8658 | Cutting Edge | 1215 | 280 | 35 | 8 | 1" | 85.1 |
| 1U1539 | Cutting Edge | 1117 | 280 | 25 | 7 | 5/8" | 58.7 |

TEL: +86 574 88220258
FAX: +86 574 88220259
E-mail: xu@china-yasheng.com

Industrial Park,Hengxi Town Yinzhou,Ningbo,Zhejiang,China
All the dimensions in this catalog are subject to our final confirmation
(以上信息均以我司确认为准) 2014-11-22

http: //www.yassian.com

宁波亚升铸业有限公司
Ningbo Yasheng Casting Industry Co.Ltd

| DBF Cutting Edge | | | | | | | |
|--------------------------|------------------------|----------------------------|---------------------------|-------------------------------|---------------------------|---------------------------------|-----------------------------|
| Part Number 型号 | Part Name 品名 | Length 长 (mm) | Width 宽 (mm) | Thickness 厚 (mm) | No. of Holes 孔数 | Bolt Dia 螺栓 (inch) | Weight 重量 (kg) |
| 145-7846 | Cutting Edge | 1108 | 280 | 35 | 7 | 7/8" | 78 |
| 135-6537 | Cutting Edge | 1108 | 280 | 25 | 7 | 7/8" | 59 |
| 6Y6360 | Cutting Edge | 1094 | 280 | 35 | 7 | 1" | 76.7 |
| 7T6589 | Cutting Edge | 1095 | 280 | 25 | 7 | 7/8" | 56.9 |
| 9W9794 | Cutting Edge | 1062 | 280 | 25 | 7 | 7/8" | 55.3 |
| 9W9796 | Cutting Edge | 1062 | 280 | 25 | 7 | 3/4" | 55.1 |
| 1U1535 | Cutting Edge | 1041 | 280 | 25 | 7 | 5/8" | 54.6 |
| 9W8657 | Cutting Edge | 1034 | 280 | 35 | 7 | 1" | 72.4 |
| 7T6591 | > Cutting Edge | 983 | 280 | 25 | 6 | 7/8" | 50.7 |
| 9W8655 | Cutting Edge | 923 | 280 | 35 | 6 | 1" | 64.6 |
| 6Y6762 | Cutting Edge | 922 | 280 | 35 | 6 | 7/8" | 64.8 |
| 6Y6761 | Cutting Edge | 910 | 280 | 35 | 6 | 7/8" | 63.9 |
| 107-3362 | > Cutting Edge | 908 | 280 | 35 | 6 | 7/8" | 63.2 |
| 7T6936 | > Cutting Edge | 908 | 280 | 25 | 6 | 7/8" | 46.5 |
| 107-3363 | Cutting Edge | 894 | 280 | 35 | 6 | 7/8" | 62.8 |
| 7T6678 | Cutting Edge | 894 | 280 | 25 | 6 | 7/8" | 46 |
| 6Y6358 | Cutting Edge | 856 | 280 | 35 | 6 | 7/8" | 60.1 |
| 9W9792 | Cutting Edge | 817 | 280 | 25 | 5 | 7/8" | 42.5 |
| 6Y6359 | > Cutting Edge | 810 | 280 | 35 | 5 | 7/8" | 56.5 |
| 9W8656 | > Cutting Edge | 779 | 280 | 35 | 5 | 7/8" | 54.3 |
| 9W9795 | Cutting Edge | 758 | 280 | 25 | 5 | 7/8" | 39.4 |
| 7T6592 | Cutting Edge | 567 | 280 | 25 | 4 | 7/8" | 29.5 |

TEL: +86 574 88220258
FAX: +86 574 88220259
E-mail: xu@china-yasheng.com

Industrial Park,Hengxi Town Yinzhou,Ningbo,Zhejiang,China
All the dimensions in this catalog are subject to our final confirmation
(以上信息均以我司确认为准) 2014-11-22
<http://www.yassian.com>

宁波亚升铸业有限公司
Ningbo Yasheng Casting Industry Co.Ltd

| DBF Cutting Edge | | | | | | | |
|--------------------------|------------------------|----------------------------|---------------------------|-------------------------------|---------------------------|---------------------------------|-----------------------------|
| Part Number 型号 | Part Name 品名 | Length 长 (mm) | Width 宽 (mm) | Thickness 厚 (mm) | No. of Holes 孔数 | Bolt Dia 螺栓 (inch) | Weight 重量 (kg) |
| 4T2951 | Cutting Edge | 3043.6 | 254 | 19 | 20 | 7/8" | 104 |
| 4T2866 | Cutting Edge | 2790.8 | 254 | 25 | 18 | 7/8" | 128 |
| 4T6509 | Cutting Edge | 2534 | 254 | 25 | 17 | 7/8" | 117.2 |
| 4T2864 5J6850 | Cutting Edge | 2332 | 254 | 25 | 23 | 3/4" | 107.4 |
| 4T2954 5J6856 | Cutting Edge | 2332 | 254 | 19 | 23 | 3/4" | 80.4 |
| 4T2867 5J6809 | Cutting Edge | 2040 | 254 | 25 | 13 | 7/8" | 94.4 |
| 4T6515 5J6807 | Cutting Edge | 1773 | 254 | 25 | 12 | 7/8" | 81.9 |
| 4T2888 5J6851 | Cutting Edge | 1621 | 254 | 25 | 16 | 3/4" | 74.6 |
| 4T2943 5J6890 | Cutting Edge | 1621 | 254 | 19 | 16 | 3/4" | 55.9 |
| 4T2950 5J6891 | Cutting Edge | 1561 | 254 | 19 | 10 | 3/4" | 54.3 |
| 4T6514 5J6811 | Cutting Edge | 1558 | 254 | 25 | 10 | 7/8" | 73.2 |
| 4T3418 6J7116 | Cutting Edge | 1533 | 254 | 25 | 10 | 7/8" | 71.6 |
| 107-3476 | Cutting Edge | 1532 | 254 | 45 | 10 | 7/8" | 123.4 |
| 4T6351 | Cutting Edge | 1521 | 254 | 25 | 10 | 7/8" | 70.2 |
| 107-3477 | Cutting Edge | 1520 | 254 | 45 | 10 | 7/8" | 122.4 |
| 107-3478 | > Cutting Edge | 1520 | 254 | 45 | 10 | 7/8" | 121.2 |
| 4T6513 5J6894 | > Cutting Edge | 1520 | 254 | 25 | 10 | 7/8" | 69.6 |
| 4T6531 5J6831 | Cutting Edge | 1520 | 254 | 25 | 10 | 7/8" | 71.3 |
| 4T2863 6J2348 | Cutting Edge | 1519 | 254 | 25 | 15 | 3/4" | 70 |
| 4T2949 6J2349 | Cutting Edge | 1519 | 254 | 19 | 15 | 3/4" | 52.3 |
| 4T2862 5J6834 | Cutting Edge | 1418 | 254 | 25 | 14 | 3/4" | 65.3 |
| 4T2889 5J6810 | Cutting Edge | 1408 | 254 | 25 | 9 | 7/8" | 65.2 |

TEL: +86 574 88220258
FAX: +86 574 88220259
E-mail: xu@china-yasheng.com

Industrial Park,Hengxi Town Yinzhou,Ningbo,Zhejiang,China
All the dimensions in this catalog are subject to our final confirmation
(以上信息均以我司确认为准) 2014-11-22
<http://www.yassian.com>

宁波亚升铸业有限公司
Ningbo Yasheng Casting Industry Co.Ltd

| DBF Cutting Edge | | | | | | | |
|--------------------------|------------------------|----------------------------|---------------------------|-------------------------------|---------------------------|---------------------------------|-----------------------------|
| Part Number 型号 | Part Name 品名 | Length 长 (mm) | Width 宽 (mm) | Thickness 厚 (mm) | No. of Holes 孔数 | Bolt Dia 螺栓 (inch) | Weight 重量 (kg) |
| 6Y5380 | Cutting Edge | 1398 | 254 | 35 | 9 | 7/8" | 89.2 |
| 6Y5379 | Cutting Edge | 1394 | 254 | 25 | 9 | 7/8" | 64.5 |
| 106-0956 | > Cutting Edge | 1380 | 254 | 19 | 9 | 3/4" | 47.5 |
| 4T2890 5J6896 | > Cutting Edge | 1359 | 254 | 25 | 9 | 3/4" | 62.3 |
| 4T3421 7J2850 | > Cutting Edge | 1357 | 254 | 25 | 9 | 7/8" | 62.1 |
| 4T2917 7J2362 | > Cutting Edge | 1357 | 254 | 19 | 9 | 7/8" | 46.5 |
| 4T2955 5J6895 | > Cutting Edge | 1357 | 254 | 19 | 9 | 3/4" | 46.7 |
| 4T2860 2J5094 | Cutting Edge | 1316 | 254 | 25 | 13 | 3/4" | 60.6 |
| 4T6651 | Cutting Edge | 1316 | 254 | 25 | 9 | 7/8" | 60.8 |
| 4T2944 5J6887 | Cutting Edge | 1316 | 254 | 19 | 13 | 3/4" | 45.4 |
| 6Y3840 | > Cutting Edge | 1227 | 254 | 25 | 8 | 3/4" | 57.1 |
| 9W1878 | > Cutting Edge | 1229 | 254 | 19 | 8 | 3/4" | 43 |
| 107-3484 | Cutting Edge | 1215 | 254 | 45 | 8 | 1" | 97.4 |
| 4T2994 8J9668 | Cutting Edge | 1215 | 254 | 25 | 8 | 1" | 56.5 |
| 4T3419 5J6892 | > Cutting Edge | 1215 | 254 | 25 | 12 | 3/4" | 55.4 |
| 4T6238 8J8119 | Cutting Edge | 1200 | 254 | 25 | 8 | 1" | 55.3 |
| 4T6650 | Cutting Edge | 1164 | 254 | 25 | 8 | 7/8" | 53.7 |
| 4T2990 6J0258 | Cutting Edge | 1122 | 254 | 25 | 7 | 3/4" | 52.2 |
| 4T2946 6J0256 | Cutting Edge | 1122 | 254 | 19 | 7 | 3/4" | 39.1 |
| 128-5883 | Cutting Edge | 1108 | 254 | 19 | 7 | 7/8" | 38.4 |
| 107-3483 | Cutting Edge | 1095 | 254 | 45 | 7 | 1" | 87.9 |
| 1U4931 | Cutting Edge | 1095 | 254 | 35 | 7 | 1" | 69.6 |

TEL: +86 574 88220258
FAX: +86 574 88220259
E-mail: xu@china-yasheng.com

Industrial Park, Hengxi Town Yinzhou, Ningbo, Zhejiang, China
All the dimensions in this catalog are subject to our final confirmation
(以上信息均以我司确认为准) 2014-11-22

http: //www.yassian.com

宁波亚升铸业有限公司
Ningbo Yasheng Casting Industry Co.Ltd

| DBF Cutting Edge | | | | | | | |
|--------------------------|------------------------|----------------------------|---------------------------|-------------------------------|---------------------------|---------------------------------|-----------------------------|
| Part Number 型号 | Part Name 品名 | Length 长 (mm) | Width 宽 (mm) | Thickness 厚 (mm) | No. of Holes 孔数 | Bolt Dia 螺栓 (inch) | Weight 重量 (kg) |
| 4T3901 | Cutting Edge | 1095 | 254 | 35 | 7 | 7/8" | 69.9 |
| 4T3422 3G1041 | Cutting Edge | 1095 | 254 | 25 | 7 | 1" | 50.5 |
| 4T8798 | Cutting Edge | 1076 | 254 | 25 | 7 | 7/8" | 49.8 |
| 4T2989 5J6849 | Cutting Edge | 1062 | 254 | 25 | 7 | 3/4" | 50.1 |
| 4T2993 7J9481 | Cutting Edge | 1062 | 254 | 25 | 7 | 7/8" | 48.8 |
| 4T2921 7J2363 | Cutting Edge | 1062 | 254 | 19 | 7 | 7/8" | 37.5 |
| 4T2948 5J6888 | Cutting Edge | 1062 | 254 | 19 | 7 | 3/4" | 37.2 |
| 6Y6351 | Cutting Edge | 1058 | 254 | 35 | 7 | 7/8" | 67.5 |
| 107-3479 | Cutting Edge | 1034 | 254 | 45 | 7 | 1" | 82.8 |
| 1U4933 | Cutting Edge | 1034 | 254 | 35 | 7 | 1" | 65.6 |
| 4T2988 8J8118 | Cutting Edge | 1034 | 254 | 25 | 7 | 1" | 47 |
| 4T2923 9J5228 | Cutting Edge | 1029 | 254 | 19 | 7 | 7/8" | 36 |
| 4T8797 1U1224 | > Cutting Edge | 988 | 254 | 25 | 6 | 7/8" | 45.3 |
| 4T7110 | > Cutting Edge | 988 | 254 | 19 | 6 | 7/8" | 34 |
| 1U4932 | Cutting Edge | 923 | 254 | 35 | 6 | 1" | 58.6 |
| 4T2987 8J9565 | Cutting Edge | 923 | 254 | 25 | 6 | 1" | 43.1 |
| 4T6512 6J9284 | Cutting Edge | 923 | 254 | 25 | 6 | 7/8" | 42.7 |
| 107-3475 | Cutting Edge | 922 | 254 | 45 | 6 | 7/8" | 74.2 |
| 107-3481 | Cutting Edge | 922 | 254 | 45 | 6 | 1" | 73.9 |
| 1U1192 | > Cutting Edge | 913 | 254 | 19 | 6 | 7/8" | 31.3 |
| 107-3474 | Cutting Edge | 910 | 254 | 45 | 6 | 7/8" | 73.3 |
| 4T6532 5J6832 | Cutting Edge | 910 | 254 | 25 | 6 | 7/8" | 41.7 |

TEL: +86 574 88220258
FAX: +86 574 88220259
E-mail: xu@china-yasheng.com

Industrial Park,Hengxi Town Yinzhou,Ningbo,Zhejiang,China
All the dimensions in this catalog are subject to our final confirmation
<http://www.yassian.com> (以上信息均以我司确认为准) 2014-11-22

宁波亚升铸业有限公司
Ningbo Yasheng Casting Industry Co.Ltd

| DBF Cutting Edge | | | | | | | |
|--------------------------|------------------------|----------------------------|---------------------------|-------------------------------|---------------------------|---------------------------------|-----------------------------|
| Part Number 型号 | Part Name 品名 | Length 长 (mm) | Width 宽 (mm) | Thickness 厚 (mm) | No. of Holes 孔数 | Bolt Dia 螺栓 (inch) | Weight 重量 (kg) |
| 4T2861 5J6854 | Cutting Edge | 905 | 254 | 25 | 9 | 3/4" | 41.7 |
| 6Y5359 | > Cutting Edge | 900 | 254 | 25 | 6 | 7/8" | 41.2 |
| 6Y5374 | > Cutting Edge | 899 | 254 | 35 | 6 | 7/8" | 56.7 |
| 122-9227 | Cutting Edge | 894 | 254 | 25 | 6 | 7/8" | 41.3 |
| 4T5318 | Cutting Edge | 894 | 254 | 19 | 6 | 7/8" | 31.6 |
| 109-9093 | Cutting Edge | 890 | 254 | 19 | 6 | 3/4" | 30.9 |
| 107-3482 | Cutting Edge | 856 | 254 | 45 | 6 | 1" | 68.5 |
| 1U4930 | Cutting Edge | 856 | 254 | 35 | 6 | 1" | 54.2 |
| 4T3423 9J9606 | Cutting Edge | 856 | 254 | 25 | 6 | 1" | 39.4 |
| 4T3420 7J2851 | Cutting Edge | 817 | 254 | 25 | 5 | 7/8" | 37.9 |
| 4T2916 6J9044 | Cutting Edge | 817 | 254 | 19 | 5 | 7/8" | 28.4 |
| 107-3480 | > Cutting Edge | 810 | 254 | 45 | 5 | 1" | 64.4 |
| 1U4929 | > Cutting Edge | 810 | 254 | 35 | 5 | 1" | 50 |
| 4T3417 3G6289 | > Cutting Edge | 810 | 254 | 25 | 5 | 1" | 37 |
| 4T2985 5J6812 | Cutting Edge | 802 | 254 | 25 | 5 | 3/4" | 37.9 |
| 4T2952 5J6839 | Cutting Edge | 802 | 254 | 19 | 5 | 3/4" | 28 |
| 107-3473 | > Cutting Edge | 780 | 254 | 45 | 5 | 1" | 62 |
| 4T2986 8J9564 | > Cutting Edge | 779 | 254 | 25 | 5 | 1" | 35.6 |
| 4T2992 7J2847 | Cutting Edge | 758 | 254 | 25 | 5 | 7/8" | 35 |
| 4T2922 6J5340 | Cutting Edge | 758 | 254 | 19 | 5 | 7/8" | 26.8 |
| 4T2991 6J0259 | Cutting Edge | 707 | 254 | 25 | 5 | 3/4" | 32.8 |
| 4T2945 6J0257 | Cutting Edge | 707 | 254 | 19 | 5 | 3/4" | 24.5 |

TEL: +86 574 88220258
FAX: +86 574 88220259
E-mail: xu@china-yasheng.com

Industrial Park, Hengxi Town Yinzhou, Ningbo, Zhejiang, China
All the dimensions in this catalog are subject to our final confirmation
(以上信息均以我司确认为准) 2014-11-22
<http://www.yassian.com>

宁波亚升铸业有限公司
Ningbo Yasheng Casting Industry Co.Ltd

| DBF Cutting Edge | | | | | | | |
|--------------------------|------------------------|----------------------------|---------------------------|-------------------------------|---------------------------|---------------------------------|-----------------------------|
| Part Number 型号 | Part Name 品名 | Length 长 (mm) | Width 宽 (mm) | Thickness 厚 (mm) | No. of Holes 孔数 | Bolt Dia 螺栓 (inch) | Weight 重量 (kg) |
| 4T7109 | Cutting Edge | 567 | 254 | 19 | 5 | 7/8" | 19.5 |
| 4T3024 5J9205 | Cutting Edge | 2815 | 203 | 19 | 28 | 5/8" | 77.1 |
| 4T8373 | Cutting Edge | 2587 | 203 | 19 | 17 | 5/8" | 71.9 |
| 4T8374 | Cutting Edge | 2564 | 203 | 19 | 16 | 3/4" | 70.9 |
| 4T2978 5J6861 | Cutting Edge | 2434 | 203 | 16 | 24 | 5/8" | 55.7 |
| 4T8077 | Cutting Edge | 2382 | 203 | 16 | 15 | 5/8" | 57.2 |
| 4T8075 | Cutting Edge | 2381 | 203 | 16 | 16 | 5/8" | 54.8 |
| 4T8375 | Cutting Edge | 2363 | 203 | 19 | 15 | 3/4" | 65.4 |
| 4T8076 | Cutting Edge | 2337 | 203 | 16 | 15 | 5/8" | 53.9 |
| 4T3017 5J6880 | Cutting Edge | 2335 | 203 | 19 | 15 | 3/4" | 64.5 |
| 4T2981 5J6904 | Cutting Edge | 2334 | 203 | 16 | 23 | 5/8" | 53.3 |
| 4T8070 | Cutting Edge | 2280 | 203 | 16 | 15 | 3/4" | 52.2 |
| 4T8081 | Cutting Edge | 2260 | 203 | 16 | 14 | 5/8" | 52.1 |
| 4T3014 | Cutting Edge | 2231 | 203 | 19 | 15 | 5/8" | 62 |
| 4T3023 5J6898 | Cutting Edge | 2231 | 203 | 19 | 22 | 5/8" | 61.4 |
| 4T2975 | Cutting Edge | 2231 | 203 | 16 | 15 | 5/8" | 51.4 |
| 4T2976 5J6906 | Cutting Edge | 2231 | 203 | 16 | 22 | 5/8" | 51 |
| 4T8080 | Cutting Edge | 2191 | 203 | 16 | 14 | 5/8" | 50.5 |
| 4T8074 | Cutting Edge | 2185.2 | 203 | 16 | 14 | 5/8" | 50 |
| 5R8053 | Cutting Edge | 2129 | 203 | 19 | 21 | 5/8" | 58.7 |
| 4T8079 | Cutting Edge | 2061 | 203 | 16 | 13 | 5/8" | 47.6 |
| 174-7969 | Cutting Edge | 2044.7 | 203 | 16 | 11 | 5/8" | 47.6 |

TEL: +86 574 88220258
FAX: +86 574 88220259
E-mail: xu@china-yasheng.com

Industrial Park,Hengxi Town Yinzhou,Ningbo,Zhejiang,China
All the dimensions in this catalog are subject to our final confirmation
(以上信息均以我司确认为准) 2014-11-22
<http://www.yassian.com>

宁波亚升铸业有限公司
Ningbo Yasheng Casting Industry Co.Ltd

| DBF Cutting Edge | | | | | | | |
|--------------------------|------------------------|----------------------------|---------------------------|-------------------------------|---------------------------|---------------------------------|-----------------------------|
| Part Number 型号 | Part Name 品名 | Length 长 (mm) | Width 宽 (mm) | Thickness 厚 (mm) | No. of Holes 孔数 | Bolt Dia 螺栓 (inch) | Weight 重量 (kg) |
| 4T2979 5J6874 | Cutting Edge | 2028 | 203 | 16 | 13 | 5/8" | 46.8 |
| 4T8073 | Cutting Edge | 1975 | 203 | 16 | 13 | 5/8" | 45.6 |
| 4T8068 | Cutting Edge | 1828 | 203 | 16 | 12 | 5/8" | 42.1 |
| 4T3021 5J6903 | Cutting Edge | 1824 | 203 | 19 | 18 | 5/8" | 50 |
| 4T2977 5J6862 | Cutting Edge | 1824 | 203 | 16 | 18 | 5/8" | 41.7 |
| 9W8335 | Cutting Edge | 1723 | 203 | 19 | 11 | 3/4" | 47.6 |
| 4T8084 | Cutting Edge | 1688 | 203 | 16 | 11 | 5/8" | 38.9 |
| 4T8083 | Cutting Edge | 1647 | 203 | 16 | 11 | 5/8" | 38 |
| 4T3011 8J7156 | Cutting Edge | 1619 | 203 | 19 | 11 | 3/4" | 44.9 |
| 4T2315 | Cutting Edge | 1558 | 203 | 19 | 10 | 3/4" | 43 |
| 4T2980 5J6902 | Cutting Edge | 1521 | 203 | 16 | 15 | 5/8" | 34.6 |
| 4T8072 | Cutting Edge | 1521 | 203 | 16 | 10 | 5/8" | 35.1 |
| 4T3009 6J1406 | Cutting Edge | 1520 | 203 | 19 | 10 | 3/4" | 42.5 |
| 4T3012 3G0975 | Cutting Edge | 1496 | 203 | 19 | 10 | 3/4" | 41.3 |
| 4T3004 9J6853 | Cutting Edge | 1441 | 203 | 19 | 9 | 3/4" | 40 |
| 5A8644 | Cutting Edge | 1405 | 203 | 19 | 14 | 5/8" | 38.7 |
| 1U2211 | Cutting Edge | 1395 | 203 | 19 | 9 | 3/4" | 38.6 |
| 8E7245 | Cutting Edge | 1357 | 203 | 16 | 9 | 3/4" | 31.1 |
| 102-4580 | Cutting Edge | 1319 | 203 | 19 | 8 | 3/4" | 36.5 |
| 4T3030 6J2350 | Cutting Edge | 1215 | 203 | 19 | 12 | 5/8" | 33.3 |
| 4T8940 | Cutting Edge | 1195 | 203 | 16 | 8 | 3/4" | 27.6 |
| 4T3008 7J9475 | Cutting Edge | 1164 | 203 | 19 | 11 | 5/8" | 33.6 |

TEL: +86 574 88220258
FAX: +86 574 88220259
E-mail: xu@china-yasheng.com

Industrial Park,Hengxi Town Yinzhou,Ningbo,Zhejiang,China
All the dimensions in this catalog are subject to our final confirmation
(以上信息均以我司确认为准) 2014-11-22
<http://www.yassian.com>

宁波亚升铸业有限公司
Ningbo Yasheng Casting Industry Co.Ltd

| DBF Cutting Edge | | | | | | | |
|--------------------------|------------------------|----------------------------|---------------------------|-------------------------------|---------------------------|---------------------------------|-----------------------------|
| Part Number 型号 | Part Name 品名 | Length 长 (mm) | Width 宽 (mm) | Thickness 厚 (mm) | No. of Holes 孔数 | Bolt Dia 螺栓 (inch) | Weight 重量 (kg) |
| 3G4282 | Cutting Edge | 1152 | 203 | 19 | 7 | 3/4" | 32.5 |
| 4T3025 7J9473 | Cutting Edge | 1112 | 203 | 19 | 7 | 5/8" | 30.8 |
| 5Q5438 | Cutting Edge | 1093 | 203 | 19 | 8 | 3/4" | 30.1 |
| 100-4578 | Cutting Edge | 1079 | 203 | 16 | 7 | 3/4" | 24.8 |
| 3Y0035 | Cutting Edge | 1070 | 203 | 19 | 7 | 3/4" | 29.6 |
| 8E9377 | Cutting Edge | 1057 | 203 | 16 | 7 | 3/4" | 24.4 |
| 7T9976 | Cutting Edge | 1052 | 203 | 25 | 7 | 3/4" | 39.3 |
| 4T6659 | Cutting Edge | 1052 | 203 | 19 | 7 | 3/4" | 30.4 |
| 3G6062 | Cutting Edge | 1043 | 203 | 19 | 7 | 3/4" | 28.8 |
| 7T9977 | Cutting Edge | 1019 | 203 | 25 | 7 | 3/4" | 37.6 |
| 4T6262 | Cutting Edge | 1019 | 203 | 19 | 7 | 3/4" | 28.1 |
| 4T3013 7J9477 | Cutting Edge | 1009 | 203 | 19 | 7 | 3/4" | 28.3 |
| 4T3029 8J1493 | Cutting Edge | 992 | 203 | 19 | 7 | 5/8" | 27.6 |
| 4T2982 8J4667 | Cutting Edge | 992 | 203 | 16 | 7 | 5/8" | 22.8 |
| 1U2207 | Cutting Edge | 961 | 203 | 19 | 6 | 3/4" | 26.6 |
| 140-0983 | Cutting Edge | 914 | 203 | 16 | 6 | 3/4" | 20.9 |
| 3Y0036 | Cutting Edge | 902 | 203 | 19 | 6 | 3/4" | 25 |
| 3G9306 | Cutting Edge | 883 | 203 | 16 | 6 | 3/4" | 20.4 |
| 4T3005 | Cutting Edge | 859 | 203 | 19 | 6 | 5/8" | 23.8 |
| 4T3020 7J9476 | Cutting Edge | 859 | 203 | 19 | 9 | 5/8" | 23.5 |
| 4T2973 8J1490 | Cutting Edge | 859 | 203 | 16 | 6 | 5/8" | 19.9 |
| 4T3720 | Cutting Edge | 858 | 203 | 16 | 6 | 3/4" | 19.6 |

TEL: +86 574 88220258
FAX: +86 574 88220259
E-mail: xu@china-yasheng.com

Industrial Park,Hengxi Town Yinzhou,Ningbo,Zhejiang,China
All the dimensions in this catalog are subject to our final confirmation
<http://www.yassian.com> (以上信息均以我司确认为准) 2014-11-22

宁波亚升铸业有限公司
Ningbo Yasheng Casting Industry Co.Ltd

| DBF Cutting Edge | | | | | | | |
|--------------------------|------------------------|----------------------------|---------------------------|-------------------------------|---------------------------|---------------------------------|-----------------------------|
| Part Number 型号 | Part Name 品名 | Length 长 (mm) | Width 宽 (mm) | Thickness 厚 (mm) | No. of Holes 孔数 | Bolt Dia 螺栓 (inch) | Weight 重量 (kg) |
| 4T0731 | Cutting Edge | 818 | 203 | 19 | 5 | 3/4" | 22.6 |
| 4T3006 | Cutting Edge | 808 | 203 | 19 | 5 | 5/8" | 22.5 |
| 4T2974 8J1489 | Cutting Edge | 808 | 203 | 16 | 5 | 5/8" | 19.6 |
| 4T3028 8J1488 | Cutting Edge | 674 | 203 | 19 | 4 | 5/8" | 18.8 |
| 4T2972 8J4666 | Cutting Edge | 674 | 203 | 16 | 4 | 5/8" | 15.7 |
| 7T9978 | Cutting Edge | 658 | 203 | 25 | 4 | 3/4" | 24.3 |
| 4T3010 7J9478 | Cutting Edge | 658 | 203 | 19 | 4 | 3/4" | 18.3 |
| 9U8057 | Cutting Edge | 627.2 | 203 | 19 | 4 | 3/4" | 17 |
| 8A8580 8A7907 | Cutting Edge | 624 | 203 | 16 | 4 | 5/8" | 14.4 |
| 8A8581 8A7914 | Cutting Edge | 586 | 203 | 16 | 4 | 5/8" | 13.5 |
| 4T3026 7J9474 | Cutting Edge | 554 | 203 | 19 | 4 | 5/8" | 15.3 |
| 4T3027 8J1487 | Cutting Edge | 383 | 203 | 19 | 3 | 5/8" | 10.6 |
| 4T2983 8J4665 | Cutting Edge | 383 | 203 | 16 | 3 | 5/8" | 8.8 |
| 135-9395 | Cutting Edge | 1740 | 165 | 16 | 8 | 5/8" | 32.1 |
| 141-2238 | Cutting Edge | 1309 | 165 | 16 | 8 | 5/8" | 24.2 |
| 6Y5842 | Cutting Edge | 1267 | 165 | 16 | 8 | 5/8" | 23.4 |
| 141-0413 | Cutting Edge | 1236 | 165 | 16 | 8 | 5/8" | 22.9 |
| 4T6232 | Cutting Edge | 1213 | 165 | 16 | 8 | 5/8" | 22.3 |
| 4T6231 8J7145 | Cutting Edge | 1062 | 165 | 16 | 7 | 5/8" | 19.7 |
| 140-2187 | Cutting Edge | 1008 | 165 | 16 | 6 | 5/8" | 18.7 |
| 104-9634 | Cutting Edge | 976 | 165 | 16 | 6 | 5/8" | 18.1 |
| 6Y5841 | Cutting Edge | 912 | 165 | 16 | 6 | 5/8" | 16.9 |

TEL: +86 574 88220258
FAX: +86 574 88220259
E-mail: xu@china-yasheng.com

Industrial Park,Hengxi Town Yinzhou,Ningbo,Zhejiang,China
All the dimensions in this catalog are subject to our final confirmation
(以上信息均以我司确认为准) 2014-11-22
<http://www.yassian.com>

宁波亚升铸业有限公司
Ningbo Yasheng Casting Industry Co.Ltd

| DBF Cutting Edge | | | | | | | |
|--------------------------|------------------------|----------------------------|---------------------------|-------------------------------|---------------------------|---------------------------------|-----------------------------|
| Part Number 型号 | Part Name 品名 | Length 长 (mm) | Width 宽 (mm) | Thickness 厚 (mm) | No. of Holes 孔数 | Bolt Dia 螺栓 (inch) | Weight 重量 (kg) |
| 4T6230 8J7144 | Cutting Edge | 869 | 165 | 16 | 6 | 5/8" | 15.9 |
| 5F3102 | Cutting Edge | 1416 | 152 | 16 | 14 | 5/8" | 23.6 |
| 7T3492 | Cutting Edge | 1112 | 203 | 25 | 7 | 7/8" | 40.5 |
| 7T3492-HD | Cutting Edge | 1112 | 254 | 30 | 7 | 7/8" | 62 |
| 4Z8119 | Grader Blade | 1219 | 203 | 19 | 6 | 5/8" | 34 |
| 135-9692 | Grader Blade | 1219 | 203 | 25 | 9 | 5/8" | 45.3 |
| 4Z8926 | Grader Blade | 1219 | 203 | 25 | 9 | 3/4" | 44.8 |
| 4T2967 5J6967 | Grader Blade | 1524 | 203 | 16 | 11 | 5/8" | 35.1 |
| 4Z8120 | Grader Blade | 1524 | 203 | 16 | 11 | 3/4" | 34.9 |
| 4T3034 8J5352 | Grader Blade | 1524 | 203 | 19 | 11 | 5/8" | 42.3 |
| 7T3497 4T2239 | Grader Blade | 1524 | 203 | 25 | 11 | 5/8" | 56.6 |
| 4T2968 5J6971 | Grader Blade | 1828 | 203 | 16 | 13 | 5/8" | 42.1 |
| 4T2971 6J2375 | Grader Blade | 1828 | 203 | 16 | 13 | 3/4" | 41.8 |
| 4T3007 5J6970 | Grader Blade | 1828 | 203 | 19 | 13 | 5/8" | 51 |
| 4T3033 6J2374 | Grader Blade | 1828 | 203 | 19 | 13 | 3/4" | 50.4 |
| 7T3499 4T2243 | Grader Blade | 1828 | 203 | 25 | 13 | 5/8" | 67.9 |
| 7T3493 4T2232 | Grader Blade | 1828 | 203 | 25 | 13 | 3/4" | 67.4 |
| 4T2969 5J6972 | Grader Blade | 2133 | 203 | 16 | 15 | 5/8" | 49.1 |
| 4T2970 6J2376 | Grader Blade | 2133 | 203 | 16 | 15 | 3/4" | 48.8 |
| 4T3036 5J6973 | Grader Blade | 2133 | 203 | 19 | 15 | 5/8" | 59.2 |
| 4T3032 6J2377 | Grader Blade | 2133 | 203 | 19 | 15 | 3/4" | 58.8 |
| 7T3498 4T2241 | Grader Blade | 2133 | 203 | 25 | 15 | 5/8" | 79.2 |

TEL: +86 574 88220258
FAX: +86 574 88220259
E-mail: xu@china-yasheng.com

Industrial Park,Hengxi Town Yinzhou,Ningbo,Zhejiang,China
All the dimensions in this catalog are subject to our final confirmation
(以上信息均以我司确认为准) 2014-11-22

http: //www.yassian.com

宁波亚升铸业有限公司
Ningbo Yasheng Casting Industry Co.Ltd

| DBF Cutting Edge | | | | | | | |
|--------------------------|------------------------|----------------------------|---------------------------|-------------------------------|---------------------------|---------------------------------|-----------------------------|
| Part Number 型号 | Part Name 品名 | Length 长 (mm) | Width 宽 (mm) | Thickness 厚 (mm) | No. of Holes 孔数 | Bolt Dia 螺栓 (inch) | Weight 重量 (kg) |
| 7T3494 4T2234 | Grader Blade | 2133 | 203 | 25 | 15 | 3/4" | 78.6 |
| 4T2966 5J6965 | Grader Blade | 2438 | 203 | 16 | 17 | 5/8" | 56.2 |
| 4T9603 | Grader Blade | 2438 | 203 | 16 | 17 | 3/4" | 55.8 |
| 4T3035 5J6966 | Grader Blade | 2438 | 203 | 19 | 17 | 5/8" | 67.7 |
| 4T3037 6D4201 | Grader Blade | 2438 | 203 | 19 | 17 | 3/4" | 67.36 |
| 7T3496 4T2238 | Grader Blade | 2438 | 203 | 25 | 17 | 5/8" | 90.5 |
| 7T3495 4T2235 | Grader Blade | 2438 | 203 | 25 | 17 | 3/4" | 89.9 |
| 4T6502 8D7702 | Grader Blade | 1828 | 254 | 25 | 13 | 3/4" | 84.9 |
| 4T6508 8D0173 | Grader Blade | 2133 | 254 | 25 | 15 | 3/4" | 99.4 |
| 4T8316 | Grader Blade | 2133 | 254 | 35 | 15 | 3/4" | 137.3 |
| 4T6511 8D0226 | Grader Blade | 2438 | 254 | 25 | 17 | 3/4" | 113.3 |
| 4T8317 | Grader Blade | 2438 | 254 | 35 | 17 | 3/4" | 156.4 |
| 104-3628 | Grader Blade | 2438 | 254 | 45 | 17 | 3/4" | 197.8 |
| 106-6420 | Wear Plate Edge | 828 | 660 | 40 | 6 | 1-1/4" | 167 |
| 618364 | Wear Plate Edge | 886 | 660 | 40 | 6 | 1-1/4" | 178.9 |
| 127-7429 | Wear Plate Edge | 886 | 660 | 50 | 6 | 1-1/4" | 222.4 |
| 106-6378 | Wear Plate Edge | 1430 | 590 | 40 | 6 | 1-1/4" | 259.4 |
| 618367 | / / Wear Plate Edge | 1066 | 590 | 40 | 6 | 1-1/4" | 192.4 |
| 127-7432 | / / Wear Plate Edge | 1066 | 590 | 50 | 6 | 1-1/4" | 237.9 |
| 618365 | / / Wear Plate Edge | 1066 | 590 | 40 | 6 | 1-1/4" | 192.4 |
| 127-7433 | / / Wear Plate Edge | 1066 | 590 | 50 | 6 | 1-1/4" | 237.9 |
| 106-6421 | / / Wear Plate Edge | 1029.5 | 590 | 40 | 6 | 1-1/4" | 185.7 |

TEL: +86 574 88220258
FAX: +86 574 88220259
E-mail: xu@china-yasheng.com

Industrial Park,Hengxi Town Yinzhou,Ningbo,Zhejiang,China
All the dimensions in this catalog are subject to our final confirmation
(以上信息均以我司确认为准) 2014-11-22
<http://www.yassian.com>

宁波亚升铸业有限公司
Ningbo Yasheng Casting Industry Co.Ltd

| DBF Cutting Edge | | | | | | | |
|--------------------------|------------------------|----------------------------|---------------------------|-------------------------------|---------------------------|---------------------------------|-----------------------------|
| Part Number 型号 | Part Name 品名 | Length 长 (mm) | Width 宽 (mm) | Thickness 厚 (mm) | No. of Holes 孔数 | Bolt Dia 螺栓 (inch) | Weight 重量 (kg) |
| 106-6423 | / / Wear Plate Edge | 1029.5 | 590 | 40 | 6 | 1-1/4" | 185.7 |
| 618368 | / / Wear Plate Edge | 946 | 590 | 40 | 6 | 1-1/4" | 170.4 |
| 127-7430 | / / Wear Plate Edge | 946 | 590 | 50 | 6 | 1-1/4" | 210.6 |
| 618366 | / / Wear Plate Edge | 946 | 590 | 40 | 6 | 1-1/4" | 170.4 |
| 127-7431 | / / Wear Plate Edge | 946 | 590 | 50 | 6 | 1-1/4" | 210.6 |
| 135-9548 | / / Wear Plate Edge | 858.1 | 590 | 40 | 10 | 1-1/4" | 151.8 |
| 135-9549 | / / Wear Plate Edge | 858.1 | 590 | 40 | 10 | 1-1/4" | 151.8 |
| 106-6377 | Wear Plate Edge | 810 | 590 | 40 | 5 | 1-1/4" | 146 |
| 9W8250 | Wear Plate Edge | 1464 | 482.5 | 35 | 3 | 1-1/4" | 189.3 |
| 9W8249 | Wear Plate Edge | 1104.5 | 482.5 | 35 | 4 | 1-1/4" | 141.9 |
| 9W5736 4T7185 | / / Wear Plate Edge | 791 | 482.5 | 35 | 6 | 1-1/4" | 100 |
| 9W5731 4T7186 | / / Wear Plate Edge | 791.5 | 482.5 | 35 | 6 | 1-1/4" | 100.1 |
| 9W5735 4T7187 | / / Wear Plate Edge | 731 | 482.5 | 35 | 5 | 1-1/4" | 92.7 |
| 9W5732 4T7188 | / / Wear Plate Edge | 731 | 482.5 | 35 | 5 | 1-1/4" | 92.7 |
| 9W5733 | / / Wear Plate Edge | 706 | 482.5 | 35 | 5 | 1-1/4" | 89.5 |
| 4T7190 | Wear Plate Edge | 706 | 482.5 | 35 | 5 | 1-1/4" | 89.5 |
| 4T6589 1U1447 | Wear Plate Edge | 1666.5 | 406 | 35 | 8 | 1" | 177 |
| 104-5841 | Wear Plate Edge | 1587 | 406 | 35 | 3 | 1-1/4" | 169.5 |
| 4T6594 1U1446 | Wear Plate Edge | 1541.8 | 406 | 35 | 8 | 1" | 163.5 |
| 109-9212 | Wear Plate Edge | 1451 | 406 | 35 | 3 | 1-1/4" | 154 |
| 100-4047 | Wear Plate Edge | 1406 | 406 | 40 | 3 | 1-1/4" | 173.1 |
| 1U0762 | Wear Plate Edge | 1406 | 406 | 35 | 3 | 1-1/4" | 150 |

TEL: +86 574 88220258
FAX: +86 574 88220259
E-mail: xu@china-yasheng.com

Industrial Park, Hengxi Town, Yinzhou, Ningbo, Zhejiang, China
All the dimensions in this catalog are subject to our final confirmation
(以上信息均以我司确认为准) 2014-11-22

http: //www.yassian.com

宁波亚升铸业有限公司
Ningbo Yasheng Casting Industry Co.Ltd

| DBF Cutting Edge | | | | | | | |
|--------------------------|------------------------|----------------------------|---------------------------|-------------------------------|---------------------------|---------------------------------|-----------------------------|
| Part Number 型号 | Part Name 品名 | Length 长 (mm) | Width 宽 (mm) | Thickness 厚 (mm) | No. of Holes 孔数 | Bolt Dia 螺栓 (inch) | Weight 重量 (kg) |
| 100-4046 | Wear Plate Edge | 1319 | 406 | 35 | 3 | 1-1/4" | 140.6 |
| 100-4045 | Wear Plate Edge | 1230.5 | 406 | 35 | 3 | 1-1/4" | 131.1 |
| 4T6588 1U1449 | Wear Plate Edge | 1211 | 406 | 35 | 6 | 1" | 128.6 |
| 9W3677 | / / Wear Plate Edge | 927 | 406 | 45 | 6 | 1-1/4" | 124.3 |
| 9W3678 | / / Wear Plate Edge | 927 | 406 | 45 | 6 | 1-1/4" | 124.3 |
| 9W3676 | Wear Plate Edge | 917 | 406 | 45 | 4 | 1-1/4" | 124.3 |
| 4T6590 1U1448 | Wear Plate Edge | 859 | 406 | 35 | 4 | 1" | 91.3 |
| 4T6592 1U1445 | Wear Plate Edge | 857.6 | 406 | 35 | 4 | 1" | 91.1 |
| 4T7145 | / / Wear Plate Edge | 734.6 | 406 | 35 | 4 | 1-1/4" | 77.2 |
| 4T7144 | / / Wear Plate Edge | 734.6 | 406 | 35 | 4 | 1-1/4" | 77.2 |
| 4T7143 | / / Wear Plate Edge | 682.2 | 406 | 35 | 4 | 1-1/4" | 71.5 |
| 4T7142 | / / Wear Plate Edge | 682.2 | 406 | 35 | 4 | 1-1/4" | 71.5 |
| 4T7141 | Wear Plate Edge | 620 | 406 | 35 | 4 | 1-1/4" | 64.7 |
| 107-8586 | Wear Plate Edge | 620 | 406 | 45 | 4 | 1-1/4" | 83.1 |
| 9W1375 | Wear Plate Edge | 1524 | 400 | 35 | 3 | 1-1/4" | 160.3 |
| 4T5273 | Wear Plate Edge | 1337 | 400 | 35 | 3 | 1-1/4" | 140.4 |
| 139-9230 | Wear Plate Edge | 1285 | 360 | 30 | 3 | 1" | 97 |
| 1U2406 1U0592 | Wear Plate Edge | 1230.5 | 360 | 30 | 3 | 1-1/4" | 92.5 |
| 1U1478 9J0292 | Wear Plate Edge | 1403.5 | 360 | 30 | 8 | 1" | 105 |
| 1U1476 | Wear Plate Edge | 1403.5 | 360 | 30 | 8 | 1" | 105 |
| 100-6668 | Wear Plate Edge | 1399.5 | 360 | 30 | 3 | 1-1/4" | 104.6 |
| 1U1909 | Wear Plate Edge | 1260 | 360 | 30 | 3 | 1-1/4" | 94.9 |

TEL: +86 574 88220258
FAX: +86 574 88220259
E-mail: xu@china-yasheng.com

Industrial Park, Hengxi Town Yinzhou, Ningbo, Zhejiang, China
All the dimensions in this catalog are subject to our final confirmation
(以上信息均以我司确认为准) 2014-11-22

http: //www.yassian.com

宁波亚升铸业有限公司
Ningbo Yasheng Casting Industry Co.Ltd

| DBF Cutting Edge | | | | | | | |
|--------------------------|------------------------|----------------------------|---------------------------|-------------------------------|---------------------------|---------------------------------|-----------------------------|
| Part Number 型号 | Part Name 品名 | Length 长 (mm) | Width 宽 (mm) | Thickness 厚 (mm) | No. of Holes 孔数 | Bolt Dia 螺栓 (inch) | Weight 重量 (kg) |
| 1U0593 | Wear Plate Edge | 1319 | 360 | 30 | 3 | 1-1/4" | 99.5 |
| 107-3381 | Wear Plate Edge | 1242 | 360 | 30 | 3 | 1" | 93.7 |
| 1U2407 | Wear Plate Edge | 1222.5 | 360 | 30 | 3 | 1-1/4" | 92.1 |
| 1U0601 | Wear Plate Edge | 1210 | 360 | 30 | 3 | 1" | 91.6 |
| 132-1034 | Wear Plate Edge | 1210 | 360 | 35 | 3 | 1" | 108.7 |
| 1U2409 | Wear Plate Edge | 1205 | 360 | 30 | 3 | 1-1/4" | 90.8 |
| 1U2413 | Wear Plate Edge | 1162 | 360 | 30 | 3 | 1" | 88 |
| 132-1032 | Wear Plate Edge | 1162 | 360 | 35 | 3 | 1" | 104.3 |
| 1U2412 | Wear Plate Edge | 1148 | 360 | 30 | 3 | 1" | 86.9 |
| 132-1031 | Wear Plate Edge | 1148 | 360 | 35 | 3 | 1" | 103 |
| 1U1473 9J6125 | Wear Plate Edge | 1140.2 | 360 | 30 | 4 | 1" | 86 |
| 1U1471 | Wear Plate Edge | 1121.1 | 360 | 30 | 4 | 1" | 84.5 |
| 1U0591 | Wear Plate Edge | 1106 | 360 | 30 | 3 | 1-1/4" | 83.2 |
| 1U0600 | Wear Plate Edge | 1079 | 360 | 30 | 3 | 1" | 81.6 |
| 1U1479 9J0293 | Wear Plate Edge | 1066.6 | 360 | 30 | 6 | 1" | 79.8 |
| 1U2411 | Wear Plate Edge | 1056 | 360 | 30 | 3 | 1" | 79.8 |
| 1U2414 | Wear Plate Edge | 1044 | 360 | 30 | 3 | 1" | 78.9 |
| 132-1030 | Wear Plate Edge | 1044 | 360 | 35 | 3 | 1" | 93.6 |
| 1U2408 | Wear Plate Edge | 1017.5 | 360 | 30 | 3 | 1-1/4" | 76.5 |
| 1U1470 | Wear Plate Edge | 990.5 | 360 | 30 | 4 | 1" | 74.5 |
| 132-1028 | Wear Plate Edge | 990.5 | 360 | 35 | 4 | 1" | 88.4 |
| 1U0599 | Wear Plate Edge | 976 | 360 | 30 | 3 | 1" | 73.7 |

TEL: +86 574 88220258
FAX: +86 574 88220259
E-mail: xu@china-yasheng.com

Industrial Park, Hengxi Town Yinzhou, Ningbo, Zhejiang, China
All the dimensions in this catalog are subject to our final confirmation
(以上信息均以我司确认为准) 2014-11-22
<http://www.yassian.com>

宁波亚升铸业有限公司
Ningbo Yasheng Casting Industry Co.Ltd

| DBF Cutting Edge | | | | | | | |
|--------------------------|------------------------|----------------------------|---------------------------|-------------------------------|---------------------------|---------------------------------|-----------------------------|
| Part Number 型号 | Part Name 品名 | Length 长 (mm) | Width 宽 (mm) | Thickness 厚 (mm) | No. of Holes 孔数 | Bolt Dia 螺栓 (inch) | Weight 重量 (kg) |
| 1U2410 | Wear Plate Edge | 960 | 360 | 30 | 3 | 1" | 72.5 |
| 1U1469 | Wear Plate Edge | 841 | 360 | 30 | 3 | 1" | 63.4 |
| 132-1029 | Wear Plate Edge | 841 | 360 | 35 | 3 | 1" | 75.3 |
| 1U1475 | Wear Plate Edge | 755.5 | 360 | 30 | 4 | 1" | 56.7 |
| 1U1531 7K3890 | Wear Plate Edge | 660.2 | 360 | 30 | 4 | 3/4" | 49.7 |
| 4T9126 | / / Wear Plate Edge | 655 | 360 | 30 | 3 | 1-1/4" | 48.8 |
| 4T9125 | / / Wear Plate Edge | 655 | 360 | 30 | 3 | 1-1/4" | 48.8 |
| 4T9128 | / / Wear Plate Edge | 637 | 360 | 30 | 4 | 1-1/4" | 47 |
| 4T9127 | / / Wear Plate Edge | 637 | 360 | 30 | 4 | 1-1/4" | 47 |
| 7T5963 | / / Wear Plate Edge | 630 | 360 | 30 | 4 | 1-1/4" | 46.5 |
| 7T5961 | / / Wear Plate Edge | 629 | 360 | 30 | 4 | 1-1/4" | 46.4 |
| 4T9185 | Wear Plate Edge | 572 | 360 | 30 | 4 | 1-1/4" | 42 |
| 7T5960 | / / Wear Plate Edge | 537 | 360 | 30 | 4 | 1-1/4" | 39.4 |
| 7T5964 | / / Wear Plate Edge | 537 | 360 | 30 | 4 | 1-1/4" | 39.4 |
| 7T5962 | Wear Plate Edge | 528 | 360 | 30 | 4 | 1-1/4" | 38.7 |
| 140-7601 | Wear Plate Edge | 290 | 360 | 30 | 2 | 1" | 21.4 |
| 107-3746 | Wear Plate Edge | 1180 | 280 | 25 | 3 | 1" | 62 |
| 1U0292 | Wear Plate Edge | 1162 | 280 | 25 | 3 | 1" | 61.2 |
| 8A8444 | Wear Plate Edge | 1128 | 280 | 25 | 3 | 1" | 59.4 |
| 8E4567 | Wear Plate Edge | 1102 | 280 | 25 | 3 | 1" | 57.8 |
| 1U0607 | Wear Plate Edge | 1044 | 280 | 25 | 3 | 1" | 54.9 |
| 1U1467 9J0291 | Wear Plate Edge | 1035 | 280 | 25 | 4 | 1" | 54.2 |

TEL: +86 574 88220258
FAX: +86 574 88220259
E-mail: xu@china-yasheng.com

Industrial Park, Hengxi Town Yinzhou, Ningbo, Zhejiang, China
All the dimensions in this catalog are subject to our final confirmation
(以上信息均以我司确认为准) 2014-11-22
<http://www.yassian.com>

宁波亚升铸业有限公司
Ningbo Yasheng Casting Industry Co.Ltd

| DBF Cutting Edge | | | | | | | |
|--------------------------|------------------------|----------------------------|---------------------------|-------------------------------|---------------------------|---------------------------------|-----------------------------|
| Part Number 型号 | Part Name 品名 | Length 长 (mm) | Width 宽 (mm) | Thickness 厚 (mm) | No. of Holes 孔数 | Bolt Dia 螺栓 (inch) | Weight 重量 (kg) |
| 1U0295 | Wear Plate Edge | 1025 | 280 | 25 | 3 | 1" | 53.4 |
| 4T9563 | Wear Plate Edge | 967 | 280 | 25 | 3 | 1" | 50.8 |
| 1U0293 | Wear Plate Edge | 941 | 280 | 25 | 3 | 1" | 49.5 |
| 1U0294 | Wear Plate Edge | 878 | 280 | 25 | 3 | 1" | 46.2 |
| 1U0605 | Wear Plate Edge | 851 | 280 | 25 | 3 | 1" | 44.6 |
| 1U1464 | Wear Plate Edge | 818.8 | 280 | 25 | 3 | 1" | 42.9 |
| 132-1027 | Wear Plate Edge | 818.8 | 280 | 35 | 3 | 1" | 58.2 |
| 1U1465 | Wear Plate Edge | 787.8 | 280 | 25 | 3 | 1" | 41.3 |
| 132-1026 | Wear Plate Edge | 787.8 | 280 | 35 | 3 | 1" | 56 |
| 100-4043 | Wear Plate Edge | 556 | 265 | 45 | 3 | 1-1/4" | 47.1 |
| 4T2915 4T0806 | Wear Plate Edge | 1486 | 254 | 19 | 3 | 3/4" | 52.4 |
| 4T2913 1U2357 | Wear Plate Edge | 1308 | 254 | 19 | 3 | 3/4" | 46.1 |
| 4T8796 4T2802 | Wear Plate Edge | 1238 | 254 | 19 | 3 | 3/4" | 43.6 |
| 9W9943 | Wear Plate Edge | 1231 | 254 | 19 | 4 | 7/8" | 43.1 |
| 4T2911 4T0803 | Wear Plate Edge | 1143 | 254 | 19 | 4 | 3/4" | 40.1 |
| 4T2912 | Wear Plate Edge | 955 | 254 | 19 | 4 | 3/4" | 33.4 |
| 4T2919 9J6664 | Wear Plate Edge | 946 | 254 | 19 | 3 | 3/4" | 33.2 |
| 109-9215 | Wear Plate Edge | 622.3 | 254 | 35 | 4 | 3/4" | 40.5 |
| 4T2918 9J3265 | Wear Plate Edge | 585.4 | 254 | 19 | 2 | 3/4" | 20.6 |
| 9W6747 | Wear Plate Edge | 527 | 254 | 25 | 4 | 3/4" | 24.5 |
| 4T2914 1U2352 | Wear Plate Edge | 433 | 254 | 19 | 2 | 3/4" | 15.2 |
| 9W9944 | Wear Plate Edge | 372.5 | 254 | 19 | 2 | 3/4" | 13 |

TEL: +86 574 88220258
FAX: +86 574 88220259
E-mail: xu@china-yasheng.com

Industrial Park, Hengxi Town, Yinzhou, Ningbo, Zhejiang, China
All the dimensions in this catalog are subject to our final confirmation
(以上信息均以我司确认为准) 2014-11-22
<http://www.yassian.com>

宁波亚升铸业有限公司
Ningbo Yasheng Casting Industry Co.Ltd

| DBF Cutting Edge | | | | | | | |
|--------------------------|------------------------|----------------------------|---------------------------|-------------------------------|---------------------------|---------------------------------|-----------------------------|
| Part Number 型号 | Part Name 品名 | Length 长 (mm) | Width 宽 (mm) | Thickness 厚 (mm) | No. of Holes 孔数 | Bolt Dia 螺栓 (inch) | Weight 重量 (kg) |
| 4T2910 4T0804 | Wear Plate Edge | 354 | 254 | 19 | 2 | 3/4" | 12.3 |
| 118-7110 | Wear Plate Edge | 1199 | 203 | 19 | 4 | 5/8" | 33.3 |
| 9W8215 | Wear Plate Edge | 1130 | 203 | 19 | 4 | 5/8" | 32 |
| 4T8353 | Wear Plate Edge | 462.8 | 203 | 19 | 3 | 3/4" | 12.8 |
| 4T8078 2V2162 | Wear Plate Edge | 407.6 | 203 | 16 | 4 | 5/8" | 9.3 |
| 4T8372 5J6961 | Wear Plate Edge | 405 | 203 | 19 | 3 | 3/4" | 11.1 |
| 4T8085 9V1757 | Wear Plate Edge | 383.2 | 203 | 16 | 3 | 5/8" | 8.8 |
| 4T8082 9V3532 | Wear Plate Edge | 349.2 | 203 | 16 | 3 | 5/8" | 8 |
| 4T8069 | Wear Plate Edge | 301.9 | 203 | 16 | 3 | 5/8" | 6.9 |
| 4T8071 5J6953 | Wear Plate Edge | 257.4 | 203 | 16 | 3 | 5/8" | 5.9 |
| 8E3158 | / / Wear Plate Edge | 443 | 700 | 50 | 4 | 1-1/4" | 118.6 |
| 8E3159 9N4152 | / / Wear Plate Edge | 443 | 700 | 50 | 4 | 1-1/4" | 118.6 |
| 8E3157 9N4150 | Wear Plate Edge | 440 | 700 | 50 | 4 | 1-1/4" | 117.9 |
| 107-6295 | / / Wear Plate Edge | 451 | 590 | 60 | 4 | 1-1/4" | 118.4 |
| 107-6296 | / / Wear Plate Edge | 451 | 590 | 60 | 4 | 1-1/4" | 118.4 |
| 107-3531 | / / Wear Plate Edge | 451 | 590 | 50 | 4 | 1-1/4" | 99.5 |
| 107-3532 | / / Wear Plate Edge | 451 | 590 | 50 | 4 | 1-1/4" | 99.5 |
| 4T6761 | / / Wear Plate Edge | 451 | 590 | 40 | 4 | 1-1/4" | 81.8 |
| 4T6762 | / / Wear Plate Edge | 451 | 590 | 40 | 4 | 1-1/4" | 81.8 |
| 138-0862 | / / Wear Plate Edge | 451 | 590 | 40 | 4 | 1-1/4" | 81.8 |
| 138-0863 | / / Wear Plate Edge | 451 | 590 | 40 | 4 | 1-1/4" | 81.8 |
| 107-6294 | Wear Plate Edge | 410 | 590 | 60 | 4 | 1-1/4" | 107.3 |

TEL: +86 574 88220258
FAX: +86 574 88220259
E-mail: xu@china-yasheng.com

Industrial Park, Hengxi Town, Yinzhou, Ningbo, Zhejiang, China
All the dimensions in this catalog are subject to our final confirmation
(以上信息均以我司确认为准) 2014-11-22

http: //www.yassian.com

宁波亚升铸业有限公司
Ningbo Yasheng Casting Industry Co.Ltd

| DBF Cutting Edge | | | | | | | |
|--------------------------|------------------------|----------------------------|---------------------------|-------------------------------|---------------------------|---------------------------------|-----------------------------|
| Part Number 型号 | Part Name 品名 | Length 长 (mm) | Width 宽 (mm) | Thickness 厚 (mm) | No. of Holes 孔数 | Bolt Dia 螺栓 (inch) | Weight 重量 (kg) |
| 107-3530 | Wear Plate Edge | 410 | 590 | 50 | 4 | 1-1/4" | 90.1 |
| 138-0861 | Wear Plate Edge | 410 | 590 | 40 | 4 | 1-1/4" | 74.2 |
| 4T6760 | Wear Plate Edge | 410 | 590 | 40 | 4 | 1-1/4" | 74.2 |
| 9W8367 | / / Wear Plate Edge | 367 | 483 | 35 | 3 | 1-1/4" | 46.3 |
| 9W8368 | / / Wear Plate Edge | 367 | 483 | 35 | 3 | 1-1/4" | 46.3 |
| 9W5737 4T7183 | / / Wear Plate Edge | 323 | 483 | 35 | 3 | 1-1/4" | 40.1 |
| 9W5730 4T7184 | / / Wear Plate Edge | 323 | 483 | 35 | 3 | 1-1/4" | 40.1 |
| 9W5734 4T7189 | Wear Plate Edge | 312 | 483 | 35 | 3 | 1-1/4" | 38.7 |
| 107-3537 | / / Wear Plate Edge | 354 | 482 | 45 | 3 | 1-1/4" | 57.3 |
| 107-3538 | / / Wear Plate Edge | 354 | 482 | 45 | 3 | 1-1/4" | 57.3 |
| 138-0866 | / / Wear Plate Edge | 354 | 482 | 40 | 3 | 1-1/4" | 51.2 |
| 138-0867 | / / Wear Plate Edge | 354 | 482 | 40 | 3 | 1-1/4" | 51.2 |
| 101-9436 | / / Wear Plate Edge | 354 | 482 | 40 | 3 | 1-1/4" | 51.2 |
| 101-9437 | / / Wear Plate Edge | 354 | 482 | 40 | 3 | 1-1/4" | 51.2 |
| 138-0865 | Wear Plate Edge | 344 | 482 | 40 | 3 | 1-1/4" | 49.7 |
| 107-3536 | Wear Plate Edge | 342 | 482 | 45 | 3 | 1-1/4" | 55.2 |
| 101-9435 | Wear Plate Edge | 342 | 482 | 40 | 3 | 1-1/4" | 50.1 |
| 107-3491 | Wear Plate Edge | 323 | 482 | 45 | 3 | 1-1/4" | 52.1 |
| 107-3492 | Wear Plate Edge | 323 | 482 | 45 | 3 | 1-1/4" | 52.1 |
| 138-6471 | / / Wear Plate Edge | 323 | 482 | 35 | 3 | 1-1/4" | 40.5 |
| 138-6472 | / / Wear Plate Edge | 323 | 482 | 35 | 3 | 1-1/4" | 40.5 |
| 107-3490 | Wear Plate Edge | 312 | 482 | 45 | 3 | 1-1/4" | 50.2 |

TEL: +86 574 88220258
FAX: +86 574 88220259
E-mail: xu@china-yasheng.com

Industrial Park,Hengxi Town Yinzhou,Ningbo,Zhejiang,China
All the dimensions in this catalog are subject to our final confirmation
(以上信息均以我司确认为准) 2014-11-22

http: //www.yassian.com

宁波亚升铸业有限公司
Ningbo Yasheng Casting Industry Co.Ltd

| DBF Cutting Edge | | | | | | | |
|--------------------------|------------------------|----------------------------|---------------------------|-------------------------------|---------------------------|---------------------------------|-----------------------------|
| Part Number 型号 | Part Name 品名 | Length 长 (mm) | Width 宽 (mm) | Thickness 厚 (mm) | No. of Holes 孔数 | Bolt Dia 螺栓 (inch) | Weight 重量 (kg) |
| 138-6470 | Wear Plate Edge | 312 | 482 | 35 | 3 | 1-1/4" | 39 |
| 109-9080 | Wear Plate Edge | 342 | 420 | 45 | 3 | 1-1/4" | 49 |
| 109-9081-RH | / / Wear Plate Edge | 342 | 420 | 45 | 3 | 1-1/4" | 49 |
| 109-9082-LH | / / Wear Plate Edge | 342 | 420 | 45 | 3 | 1-1/4" | 49 |
| 132-1089 | Wear Plate Edge | 604 | 360 | 30 | 4 | 1-1/4" | 44.3 |
| 109-9016 | / / Wear Plate Edge | 573 | 360 | 30 | 4 | 1-1/4" | 42.1 |
| 109-9017 | / / Wear Plate Edge | 573 | 360 | 30 | 4 | 1-1/4" | 42.1 |
| 109-9019 | Wear Plate Edge | 315 | 360 | 30 | 2 | 1-1/4" | 23.4 |
| 107-8583 | / / Wear Plate Edge | 305 | 360 | 45 | 2 | 1-1/4" | 35 |
| 107-8584 | / / Wear Plate Edge | 305 | 360 | 45 | 2 | 1-1/4" | 35 |
| 4T7139 | / / Wear Plate Edge | 305 | 360 | 30 | 2 | 1-1/4" | 22.5 |
| 4T7140 | / / Wear Plate Edge | 305 | 360 | 30 | 2 | 1-1/4" | 22.5 |
| 140-6870 | Wear Plate Edge | 293 | 360 | 35 | 2 | 1-1/4" | 25.6 |
| 100-6666 | Wear Plate Edge | 293 | 360 | 30 | 2 | 1-1/4" | 21.3 |
| 107-8580 | Wear Plate Edge | 290 | 360 | 45 | 2 | 1-1/4" | 33.1 |
| 4T6700 | Wear Plate Edge | 290 | 360 | 30 | 2 | 1-1/4" | 21.3 |
| 140-6868 | Wear Plate Edge | 270 | 360 | 35 | 2 | 1-1/4" | 23.4 |
| 4T6699 | Wear Plate Edge | 270 | 360 | 30 | 2 | 1-1/4" | 19.6 |
| 140-6863 | / / Wear Plate Edge | 265 | 360 | 35 | 2 | 1-1/4" | 23 |
| 140-6864 | / / Wear Plate Edge | 265 | 360 | 35 | 2 | 1-1/4" | 23 |
| 135-9647 | / / Wear Plate Edge | 265 | 360 | 30 | 2 | 1-1/4" | 19.4 |
| 135-9649 | / / Wear Plate Edge | 265 | 360 | 30 | 2 | 1-1/4" | 19.4 |

TEL: +86 574 88220258
FAX: +86 574 88220259
E-mail: xu@china-yasheng.com

Industrial Park, Hengxi Town Yinzhou, Ningbo, Zhejiang, China
All the dimensions in this catalog are subject to our final confirmation
(以上信息均以我司确认为准) 2014-11-22

http: //www.yassian.com

宁波亚升铸业有限公司
Ningbo Yasheng Casting Industry Co.Ltd

| DBF Cutting Edge | | | | | | | |
|--------------------------|------------------------|----------------------------|---------------------------|-------------------------------|---------------------------|---------------------------------|-----------------------------|
| Part Number 型号 | Part Name 品名 | Length 长 (mm) | Width 宽 (mm) | Thickness 厚 (mm) | No. Of Holes 孔数 | Bolt Dia 螺栓 (inch) | Weight 重量 (kg) |
| 4T9123 | / / Wear Plate Edge | 265 | 360 | 30 | 2 | 1-1/4" | 19.4 |
| 132-1039 | / / Wear Plate Edge | 265 | 360 | 35 | 2 | 1-1/4" | 23 |
| 4T9124 | / / Wear Plate Edge | 265 | 360 | 30 | 2 | 1-1/4" | 19.4 |
| 132-1040 | / / Wear Plate Edge | 265 | 360 | 35 | 2 | 1-1/4" | 23 |
| 107-8582 | Wear Plate Edge | 256 | 360 | 45 | 2 | 1-1/4" | 29.1 |
| 140-6862 | Wear Plate Edge | 256 | 360 | 35 | 2 | 1-1/4" | 22.2 |
| 4T3015 | Wear Plate Edge | 256 | 360 | 30 | 2 | 1-1/4" | 18.7 |
| 140-6869 | Wear Plate Edge | 253 | 360 | 35 | 2 | 1-1/4" | 21.9 |
| 100-6664 | Wear Plate Edge | 253 | 360 | 30 | 2 | 1-1/4" | 18.5 |
| 140-6867 | Wear Plate Edge | 240 | 360 | 35 | 2 | 1-1/4" | 20.7 |
| 4T6698 | Wear Plate Edge | 240 | 360 | 30 | 2 | 1-1/4" | 18 |
| 140-6866 | Wear Plate Edge | 210 | 360 | 35 | 2 | 1-1/4" | 18 |
| 135-9648 | Wear Plate Edge | 210 | 360 | 30 | 2 | 1-1/4" | 15.3 |
| 4T6697 | Wear Plate Edge | 210 | 360 | 30 | 2 | 1-1/4" | 15.4 |
| 140-6865 | Wear Plate Edge | 190 | 360 | 35 | 2 | 1-1/4" | 16.2 |
| 4T6696 | Wear Plate Edge | 190 | 360 | 30 | 2 | 1-1/4" | 13.6 |
| 135-8219 | Wear Plate Edge | 315 | 330 | 45 | 2 | 1-1/4" | 34.3 |
| 135-9295 | / / Wear Plate Edge | 315 | 330 | 40 | 2 | 1-1/4" | 30.7 |
| 135-9296 | / / Wear Plate Edge | 315 | 330 | 40 | 2 | 1-1/4" | 30.7 |
| 135-9294 | Wear Plate Edge | 300 | 330 | 40 | 2 | 1-1/4" | 29.2 |
| 132-4715 | Wear Plate Edge | 278 | 305 | 35 | 2 | 1" | 22 |
| 132-1037 | Wear Plate Edge | 265 | 280 | 35 | 2 | 1" | 18.2 |

TEL: +86 574 88220258
FAX: +86 574 88220259
E-mail: xu@china-yasheng.com

Industrial Park,Hengxi Town Yinzhou,Ningbo,Zhejiang,China
All the dimensions in this catalog are subject to our final confirmation
(以上信息均以我司确认为准) 2014-11-22
<http://www.yassian.com>

宁波亚升铸业有限公司
Ningbo Yasheng Casting Industry Co.Ltd

| DBF Cutting Edge | | | | | | | |
|--------------------------|------------------------|----------------------------|---------------------------|-------------------------------|---------------------------|---------------------------------|-----------------------------|
| Part Number 型号 | Part Name 品名 | Length 长 (mm) | Width 宽 (mm) | Thickness 厚 (mm) | No. Of Holes 孔数 | Bolt Dia 螺栓 (inch) | Weight 重量 (kg) |
| 4T6695 | Wear Plate Edge | 265 | 280 | 25 | 2 | 1" | 13.6 |
| 8E4569 | Wear Plate Edge | 247 | 280 | 25 | 2 | 1" | 12.8 |
| 132-1035 | Wear Plate Edge | 225 | 280 | 35 | 2 | 1" | 15.8 |
| 4T6694 | Wear Plate Edge | 225 | 280 | 25 | 2 | 1" | 11.5 |
| 4T6693 | Wear Plate Edge | 210 | 280 | 25 | 2 | 1" | 10.7 |
| 132-1036 | Wear Plate Edge | 210 | 280 | 35 | 2 | 1" | 14.6 |
| 4T6692 | Wear Plate Edge | 195 | 280 | 25 | 2 | 1" | 10 |
| 4T6691 | Wear Plate Edge | 175 | 280 | 25 | 2 | 1" | 8.9 |
| 128-2872 | Wear Plate Edge | 323 | 203 | 19 | 2 | 3/4" | 9 |
| 128-2873 | Wear Plate Edge | 265 | 203 | 19 | 2 | 3/4" | 7.3 |
| 4T2947 5J6855 | Scrapper Cutting Edge | 2576 | 254 | 19 | 17 | 7/8" | 89.2 |
| 4T2939 5J6840 | Scrapper Cutting Edge | 2323 | 254 | 19 | 15 | 7/8" | 80.5 |
| 7J2977 4T6555 | Scrapper Cutting Edge | 1732 | 483 | 45 | 33 | 1" | 276.2 |
| 7J1551 4T6556 | Scrapper Cutting Edge | 1732 | 483 | 35 | 33 | 1" | 214.8 |
| 7J2981 | Scrapper Cutting Edge | 1732 | 406 | 40 | 22 | 1" | 207 |
| 7J0226 4J5125 | Scrapper Cutting Edge | 1732 | 406 | 35 | 22 | 1" | 179.4 |
| 4J8225 4T6316 | Scrapper Cutting Edge | 1732 | 406 | 35 | 22 | 1" | 179.4 |
| 4T2892 140-6762 | Scrapper Cutting Edge | 1732 | 406 | 30 | 22 | 1" | 152.9 |
| 9W4394 4T8802 | Scrapper Cutting Edge | 1730 | 406 | 40 | 22 | 1-1/4" | 199.5 |
| 9W4505 4T8795 | Scrapper Cutting Edge | 1730 | 406 | 35 | 22 | 1-1/4" | 173.2 |
| 4T2893 5J6821 | Scrapper Cutting Edge | 1682 | 406 | 30 | 22 | 1" | 148.4 |
| 4T3428 140-6764 | Scrapper Cutting Edge | 1667 | 406 | 30 | 22 | 1" | 147 |

TEL: +86 574 88220258
FAX: +86 574 88220259
E-mail: xu@china-yasheng.com

Industrial Park, Hengxi Town Yinzhou, Ningbo, Zhejiang, China
All the dimensions in this catalog are subject to our final confirmation
(以上信息均以我司确认为准) 2014-11-22
<http://www.yassian.com>

宁波亚升铸业有限公司
Ningbo Yasheng Casting Industry Co.Ltd

| DBF Cutting Edge | | | | | | | |
|--------------------------|------------------------|----------------------------|---------------------------|-------------------------------|---------------------------|---------------------------------|-----------------------------|
| Part Number 型号 | Part Name 品名 | Length 长 (mm) | Width 宽 (mm) | Thickness 厚 (mm) | No. Of Holes 孔数 | Bolt Dia 螺栓 (inch) | Weight 重量 (kg) |
| 9J1111 4T6319 | Scraper Cutting Edge | 1667 | 406 | 35 | 22 | 1" | 172.4 |
| 4T6566 9J0565 | Scraper Cutting Edge | 1580 | 406 | 25 | 20 | 1" | 115.1 |
| 9J4369 4T6310 | Scraper Cutting Edge | 1580 | 406 | 35 | 20 | 1" | 163.7 |
| 9J5899 4T6371 | Scraper Cutting Edge | 1580 | 406 | 40 | 20 | 1" | 188.8 |
| 7J2958 4T6372 | Scraper Cutting Edge | 1529 | 406 | 40 | 20 | 1" | 182.5 |
| 4J8226 4T6309 | Scraper Cutting Edge | 1529 | 406 | 35 | 20 | 1" | 158.2 |
| 4T2895 5J6827 | Scraper Cutting Edge | 1529 | 406 | 30 | 20 | 1" | 134.8 |
| 4T2887 5J6818 | Scraper Cutting Edge | 1529 | 406 | 25 | 20 | 1" | 111.3 |
| 4T6620 7J3558 | Scraper Cutting Edge | 1529 | 330 | 25 | 10 | 1" | 91.3 |
| 4T6622 7J3661 | Scraper Cutting Edge | 1508 | 330 | 25 | 17 | 7/8" | 89.9 |
| 4T2896 140-6779 | Scraper Cutting Edge | 1427 | 406 | 30 | 18 | 1" | 126.1 |
| 4T6568 5J6845 | Scraper Cutting Edge | 1427 | 406 | 25 | 18 | 1" | 104 |
| 4T6626 7J3790 | Scraper Cutting Edge | 1405 | 330 | 25 | 16 | 3/4" | 84.4 |
| 4T2882 5J6914 | Scraper Cutting Edge | 1405 | 254 | 19 | 16 | 3/4" | 48.2 |
| 7J3026 4J8228 | Scraper Cutting Edge | 1376 | 406 | 35 | 18 | 1" | 142.4 |
| 4T2900 5J6828 | Scraper Cutting Edge | 1376 | 406 | 30 | 18 | 1" | 121.4 |
| 4T6565 5J6817 | Scraper Cutting Edge | 1376 | 406 | 25 | 18 | 1" | 100.2 |
| 4T6617 7J3678 | Scraper Cutting Edge | 1376 | 330 | 25 | 9 | 1" | 83 |
| 7J2957 4T6375 | Scraper Cutting Edge | 1376 | 406 | 40 | 18 | 1" | 164.2 |
| 4T6627 7J3688 | Scraper Cutting Edge | 1376 | 330 | 25 | 18 | 7/8" | 81.6 |
| 4T2941 5J6844 | Scraper Cutting Edge | 1376 | 254 | 19 | 9 | 7/8" | 47.7 |
| 4T2881 5J6916 | Scraper Cutting Edge | 1245 | 254 | 19 | 14 | 3/4" | 42.7 |

TEL: +86 574 88220258
FAX: +86 574 88220259
E-mail: xu@china-yasheng.com

Industrial Park, Hengxi Town Yinzhou, Ningbo, Zhejiang, China
All the dimensions in this catalog are subject to our final confirmation
(以上信息均以我司确认为准) 2014-11-22
<http://www.yassian.com>

宁波亚升铸业有限公司
Ningbo Yasheng Casting Industry Co.Ltd

| DBF Cutting Edge | | | | | | | |
|--------------------------|------------------------|----------------------------|---------------------------|-------------------------------|---------------------------|---------------------------------|-----------------------------|
| Part Number 型号 | Part Name 品名 | Length 长 (mm) | Width 宽 (mm) | Thickness 厚 (mm) | No. Of Holes 孔数 | Bolt Dia 螺栓 (inch) | Weight 重量 (kg) |
| 4T2891 5J6822 | Scraper Cutting Edge | 1224 | 406 | 30 | 16 | 1" | 108 |
| 4T6567 5J6819 | Scraper Cutting Edge | 1224 | 406 | 25 | 16 | 1" | 89.1 |
| 4T6621 7J3564 | Scraper Cutting Edge | 1224 | 330 | 25 | 8 | 1" | 73.8 |
| 4T6611 7J4690 | Scraper Cutting Edge | 1100 | 330 | 25 | 14 | 3/4" | 65.9 |
| 4T6625 7J3697 | Scraper Cutting Edge | 1071 | 330 | 25 | 14 | 7/8" | 63.5 |
| 4T2940 5J6843 | Scraper Cutting Edge | 1071 | 254 | 19 | 7 | 7/8" | 37.1 |
| 7J2966 4T9554 | Scraper Cutting Edge | 1062 | 330 | 40 | 7 | 1" | 105 |
| 4T2874 5J6946 | Scraper Cutting Edge | 1020 | 254 | 19 | 20 | 3/4" | 34.1 |
| 4T2962 5J6813 | Scraper Cutting Edge | 1020 | 203 | 16 | 20 | 3/4" | 22.3 |
| 9W4399 4T3892 | Scraper Cutting Edge | 964 | 330 | 35 | 8 | 1-1/4" | 80.6 |
| 9W4902 | Scraper Cutting Edge | 908 | 406 | 35 | 12 | 1" | 93.9 |
| 7J2978 4T6374 | Scraper Cutting Edge | 900 | 406 | 40 | 12 | 1" | 107.4 |
| 7J0225 4J9135 | Scraper Cutting Edge | 900 | 406 | 35 | 12 | 1" | 92 |
| 7J2959 4T9558 | Scraper Cutting Edge | 900 | 330 | 40 | 6 | 1" | 88.9 |
| 9W6092 | Scraper Cutting Edge | 900 | 330 | 35 | 6 | 1" | 77 |
| 4T6378 | Scraper Cutting Edge | 900 | 330 | 30 | 6 | 1" | 66 |
| 4T6614 7J3025 | Scraper Cutting Edge | 900 | 330 | 25 | 6 | 1" | 54.3 |
| 9J1109 4T6318 | Scraper Cutting Edge | 858 | 406 | 35 | 12 | 1" | 88.5 |
| 4T2899 140-6765 | Scraper Cutting Edge | 858 | 406 | 30 | 12 | 1" | 75.5 |
| 8J3137 4T6311 | Scraper Cutting Edge | 753 | 406 | 35 | 10 | 1" | 77.9 |
| 4T2894 144-1323 | Scraper Cutting Edge | 748 | 406 | 30 | 10 | 1" | 66 |
| 4T6380 140-6778 | Scraper Cutting Edge | 748 | 330 | 30 | 5 | 1" | 54.5 |

TEL: +86 574 88220258
FAX: +86 574 88220259
E-mail: xu@china-yasheng.com

Industrial Park, Hengxi Town, Yinzhou, Ningbo, Zhejiang, China
All the dimensions in this catalog are subject to our final confirmation
(以上信息均以我司确认为准) 2014-11-22

http: //www.yassian.com

宁波亚升铸业有限公司
Ningbo Yasheng Casting Industry Co.Ltd

| DBF Cutting Edge | | | | | | | |
|--------------------------|------------------------|----------------------------|---------------------------|-------------------------------|---------------------------|---------------------------------|-----------------------------|
| Part Number 型号 | Part Name 品名 | Length 长 (mm) | Width 宽 (mm) | Thickness 厚 (mm) | No. Of Holes 孔数 | Bolt Dia 螺栓 (inch) | Weight 重量 (kg) |
| 4T6612 7J3193 | Scraper Cutting Edge | 748 | 330 | 25 | 5 | 1" | 45.2 |
| 7J3192 5J8062 | Scraper Cutting Edge | 723 | 406 | 35 | 10 | 1" | 74.6 |
| 4T3429 140-6763 | Scraper Cutting Edge | 723 | 406 | 30 | 10 | 1" | 63.6 |
| 4T2953 5J6841 | Scraper Cutting Edge | 621 | 254 | 19 | 4 | 7/8" | 21.5 |
| 4T6624 7J3952 | Scraper Cutting Edge | 614 | 330 | 25 | 7 | 7/8" | 36.6 |
| 4T2942 5J6847 | Scraper Cutting Edge | 595 | 254 | 19 | 4 | 7/8" | 20.6 |
| 4T6613 7J4689 | Scraper Cutting Edge | 560 | 330 | 25 | 8 | 3/4" | 33.4 |
| 4T8807 7J3791 | Scraper Cutting Edge | 511 | 330 | 25 | 6 | 3/4" | 30.7 |
| 4T8808 7J3792 | Scraper Cutting Edge | 511 | 330 | 25 | 6 | 3/4" | 30.7 |
| 4T2883 5J6913 | Scraper Cutting Edge | 511 | 254 | 19 | 6 | 3/4" | 17.5 |
| 4T8833 7J3795 | Scraper Cutting Edge | 440 | 330 | 25 | 5 | 3/4" | 26.5 |
| 4T8834 7J3796 | Scraper Cutting Edge | 440 | 330 | 25 | 5 | 3/4" | 26.5 |
| 4T2884 5J6915 | Scraper Cutting Edge | 440 | 254 | 19 | 5 | 3/4" | 15.2 |
| 4T2965 5J6814 | Scraper Cutting Edge | 392 | 203 | 16 | 8 | 3/4" | 8.6 |
| 9W9701 | Scraper Cutting Edge | 1822 | 482 | 45 | 36 | 1" | 290 |
| 9W4901 | Scraper Cutting Edge | 1822 | 482 | 35 | 36 | 1" | 225.5 |
| 8J7745 | Scraper Cutting Edge | 1732 | 482 | 30 | 33 | 1" | 166 |
| 4T6373 | Scraper Cutting Edge | 1732 | 406 | 40 | 22 | 1" | 207 |
| 4T3444 9J5901 | Scraper Cutting Edge | 1580 | 406 | 30 | 20 | 1" | 139.5 |
| 9W5807 | Scraper Cutting Edge | 1510 | 406 | 25 | 18 | 1" | 110.3 |
| 7T5104 | Scraper Cutting Edge | 1486 | 330 | 25 | 18 | 7/8" | 88.4 |
| 4T2962 | Scraper Cutting Edge | 1020 | 203 | 16 | 20 | 3/4" | 22.3 |

TEL: +86 574 88220258
FAX: +86 574 88220259
E-mail: xu@china-yasheng.com

Industrial Park, Hengxi Town Yinzhou, Ningbo, Zhejiang, China
All the dimensions in this catalog are subject to our final confirmation
(以上信息均以我司确认为准) 2014-11-22
<http://www.yassian.com>

宁波亚升铸业有限公司
Ningbo Yasheng Casting Industry Co.Ltd

| DBF Cutting Edge | | | | | | | |
|--------------------------|------------------------|----------------------------|---------------------------|-------------------------------|---------------------------|---------------------------------|-----------------------------|
| Part Number 型号 | Part Name 品名 | Length 长 (mm) | Width 宽 (mm) | Thickness 厚 (mm) | No. Of Holes 孔数 | Bolt Dia 螺栓 (inch) | Weight 重量 (kg) |
| 9W4509 4T3894 | Scraper Cutting Edge | 964 | 330 | 40 | 8 | 1-1/4" | 92.9 |
| 9W9702 | Scraper Cutting Edge | 908 | 406 | 45 | 12 | 1" | 120.5 |
| 9W5738 | Scraper Cutting Edge | 900 | 482 | 35 | 12 | 1" | 113.3 |
| 4T2897 | Scraper Cutting Edge | 900 | 406 | 30 | 12 | 1" | 79.3 |
| 4J8232 9W6092 | Scraper Cutting Edge | 900 | 330 | 35 | 6 | 1" | 77 |
| 7J7225 | Scraper Cutting Edge | 757 | 406 | 35 | 10 | 1" | 78.3 |
| 7T5105 | Scraper Cutting Edge | 548 | 330 | 25 | 8 | 7/8" | 32.3 |
| 9W5806 | Scraper Cutting Edge | 536 | 406 | 25 | 8 | 1" | 38.8 |
| 9W5810 | Scraper Cutting Edge | 536 | 330 | 25 | 8 | 1" | 31.4 |
| 6Y3609 | Scraper Cutting Edge | 700 | 254 | 35 | 4 | 1" | 46 |
| 136-8759 | Corner Guard Bit | 265 | 556 | 50 | 3 | 1-1/4" | 54 |
| 100-4043 | Corner Guard Bit | 265 | 556 | 45 | 3 | 1-1/4" | 48.9 |
| 1U0761 | Corner Guard Bit | 265 | 556 | 40 | 3 | 1-1/4" | 43.7 |
| 1U0764 | / \ Corner Guard Bit | 265 | 556 | 40 | 3 | 1-1/4" | 48.5 |
| 106-9290 | Corner Guard Bit | 227 | 510 | 35 | 3 | 1-1/4" | 29.8 |
| 100-4044 | Corner Guard Bit | 200 | 556 | 40 | 3 | 1-1/4" | 32.6 |
| 3G6395 | Corner Guard Bit | 200 | 510 | 35 | 3 | 1-1/4" | 26.1 |
| 1U1897 | / \ Corner Guard Bit | 200 | 510 | 35 | 3 | 1-1/4" | 28.6 |
| 132-1033 | Corner Guard Bit | 170 | 496 | 35 | 3 | 1-1/4" | 21.2 |
| 1U1898 | / \ Corner Guard Bit | 170 | 496 | 35 | 3 | 1" | 23.7 |
| 109-3571 | Corner Guard Bit | 170 | 496 | 30 | 3 | 1-1/4" | 18.2 |
| 4T8101 | Corner Guard Bit | 170 | 496 | 30 | 3 | 1" | 18.6 |

TEL: +86 574 88220258
FAX: +86 574 88220259
E-mail: xu@china-yasheng.com

Industrial Park,Hengxi Town Yinzhou,Ningbo,Zhejiang,China
All the dimensions in this catalog are subject to our final confirmation
(以上信息均以我司确认为准) 2014-11-22

http: //www.yassian.com

宁波亚升铸业有限公司
Ningbo Yasheng Casting Industry Co.Ltd

| DBF Cutting Edge | | | | | | | |
|------------------------------|------------------------|----------------------------|---------------------------|-------------------------------|---------------------------|---------------------------------|-----------------------------|
| Part Number 型号 | Part Name 品名 | Length 长 (mm) | Width 宽 (mm) | Thickness 厚 (mm) | No. Of Holes 孔数 | Bolt Dia 螺栓 (inch) | Weight 重量 (kg) |
| 4T8091 | Corner Guard Bit | 160 | 342 | 25 | 2 | 1" | 9.8 |
| 1U1896 | / \ Corner Guard Bit | 160 | 342 | 30 | 2 | 1" | 13.2 |
| 9V0169 | Spade Blade | 2870 | 607 | 35 | / | / | 366 |
| 9V0170 | Spade Blade | 3085 | 580 | 40 | / | / | 426 |
| 104-72-21140 | Cutting Edge | 1540 | 152 | 16 | 10 | 1/2" | 26 |
| 12F-70-31251 | Cutting Edge | 760 | 152 | 16 | 5 | 5/8" | 13.2 |
| 12F-70-31261 | Cutting Edge | 914 | 152 | 16 | 6 | 5/8" | 16.3 |
| 12F-70-31281 | Cutting Edge | 1218 | 152 | 16 | 8 | 5/8" | 21.2 |
| 130-70-41130 | Cutting Edge | 1350 | 203 | 19 | 9 | 3/4" | 37.5 |
| 130-70-61170 | Cutting Edge | 1535 | 203 | 19 | 10 | 3/4" | 42.6 |
| 130-920-2180 | Cutting Edge | 1199 | 203 | 19 | 8 | 3/4" | 33.3 |
| 144-70-11131 | Cutting Edge | 1660 | 203 | 19 | 11 | 3/4" | 45.4 |
| 144-871-5130 | Cutting Edge | 1595 | 254 | 19 | 11 | 3/4" | 55 |
| 144-920-1120 14X-71-11310 | Cutting Edge | 1383 | 203 | 19 | 9 | 3/4" | 40 |
| 154-70-11313 | Cutting Edge | 1156 | 254 | 25 | 8 | 3/4" | 54.5 |
| 154-70-11314 | Cutting Edge | 1157 | 254 | 25 | 8 | 3/4" | 54.5 |
| 154-71-43190 | > Cutting Edge | 847 | 254 | 25 | 6 | 3/4" | 38 |
| 154-81-11191 | Cutting Edge | 838 | 254 | 25 | 6 | 3/4" | 39.5 |
| 175-70-21115 | Cutting Edge | 1397 | 254 | 25 | 9 | 7/8" | 65.4 |
| 175-70-26310 | Cutting Edge | 1064 | 254 | 25 | 7 | 7/8" | 49.4 |
| 175-70-26310-HD | Cutting Edge | 1064 | 254 | 30 | 7 | 7/8" | 61 |
| 175-72-21123 | > Cutting Edge | 902 | 254 | 25 | 6 | 7/8" | 42 |

TEL: +86 574 88220258
FAX: +86 574 88220259
E-mail: xu@china-yasheng.com

Industrial Park, Hengxi Town, Yinzhou, Ningbo, Zhejiang, China
All the dimensions in this catalog are subject to our final confirmation
(以上信息均以我司确认为准) 2014-11-22

http: //www.yassian.com

宁波亚升铸业有限公司
Ningbo Yasheng Casting Industry Co.Ltd

| DBF Cutting Edge | | | | | | | |
|--------------------------|------------------------|----------------------------|---------------------------|-------------------------------|---------------------------|---------------------------------|-----------------------------|
| Part Number 型号 | Part Name 品名 | Length 长 (mm) | Width 宽 (mm) | Thickness 厚 (mm) | No. Of Holes 孔数 | Bolt Dia 螺栓 (inch) | Weight 重量 (kg) |
| 17A-71-11351 | > Cutting Edge | 764 | 330 | 30 | 5 | 1" | 55 |
| 17A-71-21550 | Cutting Edge | 1088 | 330 | 30 | 7 | 1" | 79.3 |
| 17M-71-21550 | > Cutting Edge | 1088 | 330 | 30 | 7 | 1" | 78 |
| 195-70-12492 | Cutting Edge | 1327 | 330 | 30 | 9 | 1" | 96.6 |
| 195-71-11654 | Cutting Edge | 1064 | 330 | 30 | 7 | 1" | 77.5 |
| 195-71-61550 | Cutting Edge | 887 | 406 | 40 | 6 | 1-1/4" | 105.6 |
| 198-71-11181 | Cutting Edge | 1192 | 406 | 40 | 8 | 1-1/4" | 143 |
| 198-72-11181 | > Cutting Edge | 861 | 406 | 40 | 5 | 1-1/4" | 101 |
| 154-81-11190 | Cutting Edge | 838 | 254 | 25 | 6 | 3/4" | 38.9 |
| 175-71-11242 | Cutting Edge | 1509 | 254 | 25 | 10 | 7/8" | 69.8 |
| 195-72-11143 | Cutting Edge | 1975 | 406 | 30 | 13 | 1" | 177.7 |
| 195-72-11153 | Cutting Edge | 1013 | 305 | 30 | 7 | 1" | 66.7 |
| 415-815-1110 | Cutting Edge | 1054 | 203 | 19 | 5 | 5/8" | 29.4 |
| 415-815-1120 | Cutting Edge | 460 | 203 | 19 | 3 | 5/8" | 12.8 |
| 418-815-1220 | Cutting Edge | 590.5 | 330 | 35 | 2 | 1" | 51 |
| 418-815-1211 | Cutting Edge | 1495 | 330 | 30 | 4 | 1" | 110.7 |
| 421-815-2110 | Cutting Edge | 2073 | 330 | 30 | 8 | 7/8" | 153 |
| 424-815-1111 | Cutting Edge | 1748 | 330 | 30 | 6 | 7/8" | 129.2 |
| 198-71-31550 | Cutting Edge | 1192 | 406 | 45 | 8 | 1-1/4" | 159.7 |
| 417-815-1220 | Cutting Edge | 535.5 | 254 | 25 | 2 | 7/8" | 25 |
| 417-815-1210 | Cutting Edge | 1361 | 254 | 25 | 4 | 7/8" | 63.7 |
| 154-72-11151 | Cutting Edge | 910 | 254 | 25 | 6 | 3/4" | 42.9 |

TEL: +86 574 88220258
FAX: +86 574 88220259
E-mail: xu@china-yasheng.com

Industrial Park,Hengxi Town Yinzhou,Ningbo,Zhejiang,China
All the dimensions in this catalog are subject to our final confirmation
(以上信息均以我司确认为准) 2014-11-22

http: //www.yassian.com

宁波亚升铸业有限公司
Ningbo Yasheng Casting Industry Co.Ltd

| DBF Cutting Edge | | | | | | | |
|--------------------------|------------------------|----------------------------|---------------------------|-------------------------------|---------------------------|---------------------------------|-----------------------------|
| Part Number 型号 | Part Name 品名 | Length 长 (mm) | Width 宽 (mm) | Thickness 厚 (mm) | No. Of Holes 孔数 | Bolt Dia 螺栓 (inch) | Weight 重量 (kg) |
| 416-815-1220 | Cutting Edge | 516.5 | 230 | 25 | 2 | 3/4" | 21 |
| 416-815-1210 | Cutting Edge | 1297 | 230 | 25 | 4 | 3/4" | 52.5 |
| 11G-71-31170 | Cutting Edge | 380 | 160 | 16 | 4 | 5/8" | 6.9 |
| 13G-72-61410 | Cutting Edge | 1430 | 203 | 19 | 10 | 3/4" | 39.3 |
| 13G-72-61420 | Cutting Edge | 890 | 203 | 19 | 6 | 3/4" | 24.4 |
| 104-Z40-1160 | Cutting Edge | 1776 | 152 | 16 | 12 | 1/2" | 29.8 |
| 130-Z20-1510 | Cutting Edge | 1255 | 203 | 19 | 8 | 3/4" | 34.9 |
| 416-815-1110 | Cutting Edge | 1461 | 254 | 19 | 4 | 3/4" | 53 |
| 421-815-1121 | Cutting Edge | 547.7 | 330 | 30 | 4 | 7/8" | 39.6 |
| 14X-952-1130 | Cutting Edge | 1275 | 203 | 19 | 8 | 3/4" | 35.7 |
| 198-71-31540 | > Cutting Edge | 861 | 406 | 45 | 5 | 1-1/4" | 111.6 |
| 198-71-31550 | Cutting Edge | 1192 | 406 | 45 | 8 | 1-1/4" | 158.8 |
| 185506A1 | Cutting Edge | 2392.4 | 152 | 19 | 10 | 3/4" | 49 |
| 112946A1 | Cutting Edge | 2113 | 156 | 19 | 10 | 3/4" | 44.1 |
| T156530 | Cutting Edge | 1384.3 | 406 | 35 | 3 | 1-1/4" | 147 |
| U11314 | Cutting Edge | 1062.4 | 254 | 25 | 7 | 1" | 48.7 |
| U14182 | Cutting Edge | 380 | 160 | 16 | 4 | 5/8" | 6.9 |
| U11343 | Cutting Edge | 1062.4 | 254 | 25 | 7 | 1" | 48.7 |
| T157492 | Cutting Edge | 1127 | 254 | 25 | 3 | 3/4" | 52.6 |
| T167828-1316 | Cutting Edge | 1203 | 360 | 30 | 3 | 1" | 90.3 |
| T101638 | Cutting Edge | 1054 | 254 | 25 | 3 | 3/4" | 49.1 |
| T150517 | Cutting Edge | 2184.4 | 203 | 19 | 7 | 5/8" | 61.2 |

TEL: +86 574 88220258
FAX: +86 574 88220259
E-mail: xu@china-yasheng.com

Industrial Park,Hengxi Town Yinzhou,Ningbo,Zhejiang,China
All the dimensions in this catalog are subject to our final confirmation
(以上信息均以我司确认为准) 2014-11-22

http: //www.yassian.com

宁波亚升铸业有限公司
Ningbo Yasheng Casting Industry Co.Ltd

| DBF Cutting Edge | | | | | | | |
|--------------------------|------------------------|----------------------------|---------------------------|-------------------------------|---------------------------|---------------------------------|-----------------------------|
| Part Number 型号 | Part Name 品名 | Length 长 (mm) | Width 宽 (mm) | Thickness 厚 (mm) | No. Of Holes 孔数 | Bolt Dia 螺栓 (inch) | Weight 重量 (kg) |
| 504107B-42 | Cutting Edge | 1074 | 406 | 35 | 7 | 1-1/4" | 113 |
| T198126 | Cutting Edge | 955.6 | 400 | 30 | 4 | 1-1/4" | 85.3 |
| 720068NS | Cutting Edge | 1727.2 | 406 | 30 | 8 | 1" | 155 |
| 720074NS | Cutting Edge | 1879.6 | 406 | 30 | 9 | 1" | 169 |
| 710088NS | Cutting Edge | 2235.2 | 406 | 30 | 15 | 1" | 199 |
| 710064NS | Cutting Edge | 1625.6 | 406 | 30 | 11 | 1" | 145 |
| 348108-DBF-58P | Cutting Edge | 2743.2 | 203 | 19 | 11 | 5/8" | 76.4 |

TEL: +86 574 88220258
FAX: +86 574 88220259
E-mail: xu@china-yasheng.com

Industrial Park,Hengxi Town Yinzhou,Ningbo,Zhejiang,China
All the dimensions in this catalog are subject to our final confirmation
<http://www.yassian.com> (以上信息均以我司确认为准) 2014-11-22

宁波亚升铸业有限公司
Ningbo Yasheng Casting Industry Co.Ltd

SBF Cutting Edge

| PART NO. 型号 | PART NAME 品名 | Length 长 (mm) | Width 宽 (mm) | Thickness 厚 (mm) | No. Of Holes 孔数 | Bolt Dia 螺栓 (inch) | Weight 重量 (kg) |
|-----------------------|------------------------|----------------------------|---------------------------|-------------------------------|---------------------------|---------------------------------|-----------------------------|
| 7I3015 | SBF Bucket Edge | 3193 | 300 | 40 | 30 | Φ36 | 277 |
| 7V1490 | SBF Bucket Edge | 3041 | 304 | 40 | 18 | Φ35 | 271 |
| 5V7410 | SBF Bucket Edge | 2744 | 245 | 25 | 12 | Φ27.5 | 121.9 |
| 8K8161 | SBF Bucket Edge | 2438 | 245 | 25 | 18 | Φ27 | 110.5 |
| 9W6575-HD | SBF Bucket Edge | 3036 | 300 | 40 | 30 | Φ35 | 264 |
| 7V0904 | SBF Bucket Edge | 2854 | 270 | 30 | 18 | Φ36 | 167 |
| 8V1825 | SBF Bucket Edge | 2641.6 | 250 | 25 | 16 | Φ28 | 119.6 |
| 9V6573 | SBF Bucket Edge | 2734.5 | 282 | 30 | 30 | Φ28 | 167.5 |
| 9V6572 | SBF Bucket Edge | 2370 | 245 | 25 | 28 | Φ27.5 | 103.6 |
| 4E0659 | SBF Bucket Edge | 2524 | 245 | 25 | 28 | Φ27.5 | 109.5 |
| 8K8162 | SBF Bucket Edge | 2673 | 245 | 25 | 20 | Φ27 | 118.2 |
| 8K9754 | SBF Bucket Edge | 2921 | 267 | 30 | 24 | Φ28 | 169 |
| 9R5313 | SBF Bucket Edge | 2396 | 150 | 19 | 30 | Φ17.5 | 48 |
| 9R4672 | SBF Bucket Edge | 2262 | 150 | 19 | 16 | Φ17.5 | 47 |
| 5V4696 | SBF Bucket Edge | 2736 | 282 | 30 | 18 | Φ28 | 166.2 |
| 6W2990 | SBF Bucket Edge | 2856 | 282 | 30 | 30 | Φ36 | 169.1 |
| 6W2985 | SBF Bucket Edge | 2639 | 245 | 25 | 28 | Φ28 | 113.5 |
| 105-2345 | SBF Bucket Edge | 2681 | 245 | 25 | 28 | Φ27 | 116.2 |
| 3G6364 | SBF Bucket Edge | 1300 | 300 | 35 | / | / | 102 |
| 6I5234 | SBF Bucket Edge | 1350 | 300 | 40 | / | / | 121 |
| 6I5248 | SBF Bucket Edge | 1250 | 300 | 40 | / | / | 112 |
| 6W2989 | SBF Bucket Edge | 2840 | 282 | 30 | 12 | Φ36 | 178 |

TEL: +86 574 88220258
FAX: +86 574 88220259
E-mail: xu@china-yasheng.com

Industrial Park, Hengxi Town Yinzhou, Ningbo, Zhejiang, China
All the dimensions in this catalog are subject to our final confirmation
(以上信息均以我司确认为准) 2014-11-22
<http://www.yassian.com>

宁波亚升铸业有限公司
Ningbo Yasheng Casting Industry Co.Ltd

| SBF Cutting Edge | | | | | | | |
|-------------------------|------------------------|----------------------------|---------------------------|-------------------------------|---------------------------|---------------------------------|-----------------------------|
| PART NO. 型号 | PART NAME 品名 | Length 长 (mm) | Width 宽 (mm) | Thickness 厚 (mm) | No. Of Holes 孔数 | Bolt Dia 螺栓 (inch) | Weight 重量 (kg) |
| 9V6575 | SBF Bucket Edge | 3041.7 | 304.8 | 40 | 30 | Φ35 | 268.2 |
| 5G8342 | SBF Bucket Edge | 2364.7 | 190.5 | 19 | 28 | Φ20.6 | 64 |
| 5G2809 | SBF Bucket Edge | 2079.6 | 190.5 | 19 | 14 | Φ20.6 | 58 |
| 5G3085 | SBF Bucket Edge | 2150.4 | 190.5 | 19 | 14 | Φ20.6 | 60 |
| 9V6529 | SBF Bucket Edge | 3030 | 282 | 30 | 30 | Φ35 | 190 |
| 141-4847 | SBF Bucket Edge | 2920.2 | 282 | 30 | 30 | Φ27 | 176 |
| 5V7276 | SBF Bucket Edge | 2614 | 245 | 25 | 18 | Φ27 | 125 |
| 5V7423 | SBF Bucket Edge | 2439 | 245 | 25 | 18 | Φ27 | 111 |
| 5V4661 | SBF Bucket Edge | 2407.4 | 245 | 25 | 16 | Φ27 | 115 |
| 6W2986 | SBF Bucket Edge | 2413 | 245 | 25 | 30 | Φ27 | 112 |
| 9V6574 | SBF Bucket Edge | 3314.2 | 304.8 | 45 | 30 | Φ35 | 332 |
| 7V4188 | SBF Bucket Edge | 3315 | 300 | 40 | 18 | Φ36 | 293 |
| 425-70-1160 | SBF Bucket Edge | 3312 | 300 | 45 | 30 | Φ36 | 321.9 |
| 425-70-1122 | SBF Bucket Edge | 2920 | 268 | 30 | 24 | Φ28.5 | 168 |
| 425-70-1221 | SBF Bucket Edge | 3032 | 300 | 35 | 18 | Φ36 | 233 |
| 12201 | SBF Bucket Edge | 1000 | 75 | 35 | / | / | 19.3 |
| 13201 | SBF Bucket Edge | 1000 | 96 | 45 | / | / | 32.1 |
| 14201 | SBF Bucket Edge | 950 | 120 | 55 | / | / | 46.9 |
| 123/04004 | SBF Bucket Edge | 2350 | 200 | 20 | 22 | Φ21 | 69 |

TEL: +86 574 88220258
FAX: +86 574 88220259
E-mail: xu@china-yasheng.com

Industrial Park, Hengxi Town, Yinzhou, Ningbo, Zhejiang, China
All the dimensions in this catalog are subject to our final confirmation
(以上信息均以我司确认为准) 2014-11-22
<http://www.yassian.com>

宁波亚升铸业有限公司
Ningbo Yasheng Casting Industry Co.Ltd

| Dozer End Bit | | | | | | | |
|------------------|-----------------|---------------------|--------------------|------------------------|-----------------------|--------------------------|----------------------|
| PART NO. 型号 | PART NAME 品名 | Length 长 (mm) | Width 宽 (mm) | Thickness 厚 (mm) | No. of Holes 孔数 | Bolt Dia 螺栓 (inch) | Weight 重量 (kg) |
| 7T4092 | Dozer End Bit | 702 | 343 | 70 | 7 | 1" | 129.3 |
| 7T4093 | Dozer End Bit | 702 | 343 | 70 | 7 | 1" | 129.3 |
| 8E9748 | Dozer End Bit | 770 | 360 | 75 | 9 | 1-1/4" | 147.2 |
| 8E9749 | Dozer End Bit | 770 | 360 | 75 | 9 | 1-1/4" | 147.2 |
| 8E9785 | Dozer End Bit | 770 | 371 | 60 | 9 | 1-1/4" | 119.8 |
| 8E9786 | Dozer End Bit | 770 | 371 | 60 | 9 | 1-1/4" | 119.8 |
| 8E4545 9W4491 | Dozer End Bit | 821 | 412 | 50 | 7 | 1-1/4" | 127.3 |
| 8E4546 9W4492 | Dozer End Bit | 821 | 412 | 50 | 7 | 1-1/4" | 127.3 |
| 8E4543 | Dozer End Bit | 859.5 | 406 | 70 | 9 | 1-1/4" | 181 |
| 8E4544 | Dozer End Bit | 859.5 | 406 | 70 | 9 | 1-1/4" | 181 |
| 8E4541 7T4097 | Dozer End Bit | 722 | 406 | 50 | 7 | 1-1/4" | 105 |
| 8E4542 7T4096 | Dozer End Bit | 722 | 406 | 50 | 7 | 1-1/4" | 105 |
| 100-3131 | Dozer End Bit | 687 | 406 | 45 | 7 | 1-1/4" | 82.8 |
| 100-3132 | Dozer End Bit | 687 | 406 | 45 | 7 | 1-1/4" | 82.8 |
| 100-3133 | Dozer End Bit | 687 | 406 | 60 | 7 | 1-1/4" | 109.1 |
| 100-3134 | Dozer End Bit | 687 | 406 | 60 | 7 | 1-1/4" | 109.1 |
| 8E4198 | Dozer End Bit | 729 | 406 | 55 | 7 | 1-1/4" | 116 |
| 8E4199 | Dozer End Bit | 729 | 406 | 55 | 7 | 1-1/4" | 116 |
| 7T4094 | Dozer End Bit | 630 | 406 | 70 | 7 | 1" | 123.9 |
| 7T4095 | Dozer End Bit | 630 | 406 | 70 | 7 | 1" | 123.9 |
| 7T4688 9W6196 | Dozer End Bit | 691 | 406 | 60 | 7 | 1-1/4" | 113.8 |
| 7T4689 9W6197 | Dozer End Bit | 691 | 406 | 60 | 7 | 1-1/4" | 113.8 |

TEL: +86 574 88220258
FAX: +86 574 88220259
E-mail: xu@china-yasheng.com

Industrial Park, Hengxi Town, Yinzhou, Ningbo, Zhejiang, China
All the dimensions in this catalog are subject to our final confirmation
(以上信息均以我司确认为准) 2014-11-22
<http://www.yassian.com>

宁波亚升铸业有限公司
Ningbo Yasheng Casting Industry Co.Ltd

| Dozer End Bit | | | | | | | |
|-----------------------|------------------------|----------------------------|---------------------------|-------------------------------|---------------------------|---------------------------------|-----------------------------|
| PART NO. 型号 | PART NAME 品名 | Length 长 (mm) | Width 宽 (mm) | Thickness 厚 (mm) | No. of Holes 孔数 | Bolt Dia 螺栓 (inch) | Weight 重量 (kg) |
| 6Y4277 | Dozer End Bit | 592 | 330 | 40 | 7 | 1" | 51.1 |
| 6Y4278 | Dozer End Bit | 592 | 330 | 40 | 7 | 1" | 51.1 |
| 4T6389 3G4209 | Dozer End Bit | 588.4 | 330 | 30 | 5 | 1" | 42.8 |
| 9W9193 | Dozer End Bit | 701 | 330 | 50 | 7 | 1" | 86.9 |
| 3G7763 | Dozer End Bit | 610 | 316 | 35 | 7 | 1-1/4" | 49.8 |
| 3G7764 | Dozer End Bit | 610 | 316 | 35 | 7 | 1-1/4" | 49.8 |
| 1U1545 | Dozer End Bit | 677 | 316 | 40 | 7 | 1-1/4" | 59.3 |
| 1U1546 | Dozer End Bit | 677 | 316 | 40 | 7 | 1-1/4" | 59.3 |
| 3G8281 7J3461 | Dozer End Bit | 681 | 330 | 40 | 7 | 1" | 65.1 |
| 3G8282 7J3462 | Dozer End Bit | 681 | 330 | 40 | 7 | 1" | 65.1 |
| 3G8289 7J6713 | Dozer End Bit | 681 | 330 | 35 | 7 | 1" | 58.5 |
| 3G8290 7J6714 | Dozer End Bit | 681 | 330 | 35 | 7 | 1" | 58.5 |
| 5J1279 1J1985 | Dozer End Bit | 584 | 330 | 35 | 7 | 1" | 48.3 |
| 5J1280 1J1986 | Dozer End Bit | 584 | 330 | 35 | 7 | 1" | 48.3 |
| 8E4539 9W6195 | Dozer End Bit | 607 | 330 | 45 | 7 | 1" | 68 |
| 8E4540 9W6194 | Dozer End Bit | 607 | 330 | 45 | 7 | 1" | 68 |
| 100-3135 | Dozer End Bit | 581.7 | 330 | 45 | 7 | 1" | 57.6 |
| 100-3136 | Dozer End Bit | 581.7 | 330 | 45 | 7 | 1" | 57.6 |
| 100-3137 | Dozer End Bit | 581.7 | 330 | 60 | 7 | 1" | 74.7 |
| 100-3138 | Dozer End Bit | 581.7 | 330 | 60 | 7 | 1" | 74.7 |
| 100-3139 | Dozer End Bit | 556.5 | 330 | 50 | 7 | 1" | 60.1 |
| 100-3140 | Dozer End Bit | 556.5 | 330 | 50 | 7 | 1" | 60.1 |

TEL: +86 574 88220258
FAX: +86 574 88220259
E-mail: xu@china-yasheng.com

Industrial Park, Hengxi Town, Yinzhou, Ningbo, Zhejiang, China
All the dimensions in this catalog are subject to our final confirmation
(以上信息均以我司确认为准) 2014-11-22
<http://www.yassian.com>

宁波亚升铸业有限公司
Ningbo Yasheng Casting Industry Co.Ltd

| Dozer End Bit | | | | | | | |
|-----------------------|------------------------|----------------------------|---------------------------|-------------------------------|---------------------------|---------------------------------|-----------------------------|
| PART NO. 型号 | PART NAME 品名 | Length 长 (mm) | Width 宽 (mm) | Thickness 厚 (mm) | No. of Holes 孔数 | Bolt Dia 螺栓 (inch) | Weight 重量 (kg) |
| 8E4537 7T9093 | Dozer End Bit | 569 | 330 | 55 | 7 | 1" | 74.4 |
| 8E4538 7T9092 | Dozer End Bit | 569 | 330 | 55 | 7 | 1" | 74.4 |
| 8E4193 7T9089 | Dozer End Bit | 585 | 330 | 40 | 7 | 1" | 57.6 |
| 8E4194 7T9090 | Dozer End Bit | 585 | 330 | 40 | 7 | 1" | 57.6 |
| 8E4196 9W6193 | Dozer End Bit | 585 | 330 | 50 | 7 | 1" | 70 |
| 8E4197 9W6192 | Dozer End Bit | 585 | 330 | 50 | 7 | 1" | 70 |
| 4T6391 5J9321 | Dozer End Bit | 506.7 | 330 | 30 | 7 | 1" | 33.7 |
| 4T6392 5J9322 | Dozer End Bit | 506.7 | 330 | 30 | 7 | 1" | 33.7 |
| 3G8283 7J3463 | Dozer End Bit | 583 | 330 | 40 | 7 | 1" | 53.1 |
| 3G8284 7J3464 | Dozer End Bit | 583 | 330 | 40 | 7 | 1" | 53.1 |
| 3G8291 7J6711 | Dozer End Bit | 583 | 330 | 35 | 7 | 1" | 46.8 |
| 3G8292 7J6712 | Dozer End Bit | 583 | 330 | 35 | 7 | 1" | 46.8 |
| 4T8723 | Dozer End Bit | 528.6 | 310 | 35 | 7 | 1" | 41.6 |
| 4T8724 | Dozer End Bit | 528.6 | 310 | 35 | 7 | 1" | 41.6 |
| 135-9698 | Dozer End Bit | 558.8 | 330 | 35 | 6 | 1" | 41.9 |
| 135-9699 | Dozer End Bit | 558.8 | 330 | 35 | 6 | 1" | 41.9 |
| 7T4090 | Dozer End Bit | 521 | 330 | 65 | 7 | 1" | 78.8 |
| 7T4091 | Dozer End Bit | 521 | 330 | 65 | 7 | 1" | 78.8 |
| 7T4088 | Dozer End Bit | 507 | 330 | 65 | 7 | 1" | 73.9 |
| 7T4089 | Dozer End Bit | 507 | 330 | 65 | 7 | 1" | 73.9 |
| 105-0574 | Dozer End Bit | 472 | 270 | 35 | 7 | 7/8" | 33.3 |
| 105-0575 | Dozer End Bit | 472 | 270 | 35 | 7 | 7/8" | 33.3 |

TEL: +86 574 88220258
FAX: +86 574 88220259
E-mail: xu@china-yasheng.com

Industrial Park, Hengxi Town Yinzhou, Ningbo, Zhejiang, China
All the dimensions in this catalog are subject to our final confirmation
(以上信息均以我司确认为准) 2014-11-22
<http://www.yassian.com>

宁波亚升铸业有限公司
Ningbo Yasheng Casting Industry Co.Ltd

| Dozer End Bit | | | | | | | |
|-----------------------|------------------------|----------------------------|---------------------------|-------------------------------|---------------------------|---------------------------------|-----------------------------|
| PART NO. 型号 | PART NAME 品名 | Length 长 (mm) | Width 宽 (mm) | Thickness 厚 (mm) | No. of Holes 孔数 | Bolt Dia 螺栓 (inch) | Weight 重量 (kg) |
| 105-0576 | Dozer End Bit | 472 | 270 | 45 | 7 | 7/8" | 42.4 |
| 105-0577 | Dozer End Bit | 472 | 270 | 45 | 7 | 7/8" | 42.4 |
| 9W6198 7T6588 | Dozer End Bit | 600 | 280 | 35 | 7 | 7/8" | 42 |
| 9W6199 7T6587 | Dozer End Bit | 600 | 280 | 35 | 7 | 7/8" | 42 |
| 9W8653 | Dozer End Bit | 544 | 280 | 50 | 7 | 1" | 56.9 |
| 9W8654 | Dozer End Bit | 544 | 280 | 50 | 7 | 1" | 56.9 |
| 9W8651 | Dozer End Bit | 532 | 280 | 50 | 7 | 1" | 55.6 |
| 9W8652 | Dozer End Bit | 532 | 280 | 50 | 7 | 1" | 55.6 |
| 4T6505 | Dozer End Bit | 472 | 254 | 25 | 7 | 7/8" | 20.5 |
| 4T6506 | Dozer End Bit | 472 | 254 | 25 | 7 | 7/8" | 20.5 |
| 4T6241 1U0182 | Dozer End Bit | 409.1 | 254 | 25 | 7 | 7/8" | 18.1 |
| 4T6242 1U0181 | Dozer End Bit | 409.1 | 254 | 25 | 7 | 7/8" | 18.1 |
| 3G8285 7J3457 | Dozer End Bit | 531 | 254 | 40 | 7 | 7/8" | 37.4 |
| 3G8286 7J3458 | Dozer End Bit | 531 | 254 | 40 | 7 | 7/8" | 37.4 |
| 3G8287 9J1475 | Dozer End Bit | 531 | 254 | 40 | 7 | 1" | 39.3 |
| 3G8288 9J1474 | Dozer End Bit | 531 | 254 | 40 | 7 | 1" | 39.3 |
| 3G8293 5J9627 | Dozer End Bit | 531 | 254 | 25 | 7 | 7/8" | 25 |
| 3G8294 5J9628 | Dozer End Bit | 531 | 254 | 25 | 7 | 7/8" | 25 |
| 3G8315 5J8767 | Dozer End Bit | 531 | 254 | 30 | 7 | 7/8" | 28 |
| 3G8316 5J8768 | Dozer End Bit | 531 | 254 | 30 | 7 | 7/8" | 28 |
| 3G8317 8J8105 | Dozer End Bit | 531 | 254 | 30 | 7 | 1" | 28 |
| 3G8318 8J8120 | Dozer End Bit | 531 | 254 | 30 | 7 | 1" | 28 |

TEL: +86 574 88220258
FAX: +86 574 88220259
E-mail: xu@china-yasheng.com

Industrial Park, Hengxi Town Yinzhou, Ningbo, Zhejiang, China
All the dimensions in this catalog are subject to our final confirmation
(以上信息均以我司确认为准) 2014-11-22
<http://www.yassian.com>

宁波亚升铸业有限公司
Ningbo Yasheng Casting Industry Co.Ltd

| Dozer End Bit | | | | | | | |
|-----------------------|------------------------|----------------------------|---------------------------|-------------------------------|---------------------------|---------------------------------|-----------------------------|
| PART NO. 型号 | PART NAME 品名 | Length 长 (mm) | Width 宽 (mm) | Thickness 厚 (mm) | No. of Holes 孔数 | Bolt Dia 螺栓 (inch) | Weight 重量 (kg) |
| 4T6503 | Dozer End Bit | 457.2 | 254 | 25 | 7 | 7/8" | 19.3 |
| 4T6504 | Dozer End Bit | 457.2 | 254 | 25 | 7 | 7/8" | 19.3 |
| 4T6239 | Dozer End Bit | 487.1 | 254 | 25 | 7 | 1" | 19.8 |
| 4T6240 | Dozer End Bit | 487.1 | 254 | 25 | 7 | 1" | 19.8 |
| 4T8089 1U4183 | Dozer End Bit | 487 | 254 | 30 | 7 | 1" | 23.9 |
| 4T8090 1U4184 | Dozer End Bit | 487 | 254 | 30 | 7 | 1" | 23.9 |
| 8E9544 | Dozer End Bit | 507 | 254 | 35 | 7 | 7/8" | 27.9 |
| 8E9545 | Dozer End Bit | 507 | 254 | 35 | 7 | 7/8" | 27.9 |
| 9J1477 | Dozer End Bit | 481 | 254 | 30 | 7 | 1" | 26.5 |
| 9J1478 | Dozer End Bit | 481 | 254 | 30 | 7 | 1" | 26.5 |
| 4J8843 2J2571 | Dozer End Bit | 490 | 254 | 30 | 7 | 7/8" | 27 |
| 4J8844 2J2572 | Dozer End Bit | 490 | 254 | 30 | 7 | 7/8" | 27 |
| 3G8277 7J3459 | Dozer End Bit | 504 | 254 | 40 | 7 | 7/8" | 38.2 |
| 3G8278 7J3460 | Dozer End Bit | 504 | 254 | 40 | 7 | 7/8" | 38.2 |
| 3G8279 9J1473 | Dozer End Bit | 504 | 254 | 40 | 7 | 1" | 35.2 |
| 3G8280 9J1472 | Dozer End Bit | 504 | 254 | 40 | 7 | 1" | 35.2 |
| 3G8301 8J8117 | Dozer End Bit | 493 | 260 | 30 | 7 | 1" | 29 |
| 3G8302 8J8116 | Dozer End Bit | 493 | 260 | 30 | 7 | 1" | 29 |
| 3J2463 | Dozer End Bit | 430.3 | 254 | 25 | 7 | 3/4" | 21.2 |
| 3J2464 | Dozer End Bit | 430.3 | 254 | 25 | 7 | 3/4" | 21.2 |
| 4T6671 5J6929 | Dozer End Bit | 407.9 | 254 | 25 | 7 | 3/4" | 18 |
| 4T6672 5J6930 | Dozer End Bit | 407.9 | 254 | 25 | 7 | 3/4" | 18 |

TEL: +86 574 88220258
FAX: +86 574 88220259
E-mail: xu@china-yasheng.com

Industrial Park, Hengxi Town Yinzhou, Ningbo, Zhejiang, China
All the dimensions in this catalog are subject to our final confirmation
(以上信息均以我司确认为准) 2014-11-22

http: //www.yassian.com

宁波亚升铸业有限公司
Ningbo Yasheng Casting Industry Co.Ltd

| Dozer End Bit | | | | | | | |
|-----------------------|------------------------|----------------------------|---------------------------|-------------------------------|---------------------------|---------------------------------|-----------------------------|
| PART NO. 型号 | PART NAME 品名 | Length 长 (mm) | Width 宽 (mm) | Thickness 厚 (mm) | No. of Holes 孔数 | Bolt Dia 螺栓 (inch) | Weight 重量 (kg) |
| 4J8849 1J9493 | Dozer End Bit | 468.4 | 254 | 30 | 7 | 7/8" | 26 |
| 4J8850 1J9494 | Dozer End Bit | 468.4 | 254 | 30 | 7 | 7/8" | 26 |
| 9J1479 | Dozer End Bit | 468.4 | 254 | 30 | 7 | 1" | 25.5 |
| 9J1480 | Dozer End Bit | 468.4 | 254 | 30 | 7 | 1" | 25.5 |
| 6Y4410 | Dozer End Bit | 510 | 254 | 30 | 6 | 3/4" | 28.3 |
| 6Y4411 | Dozer End Bit | 510 | 254 | 30 | 6 | 3/4" | 28.3 |
| 6Y5375 | Dozer End Bit | 504 | 254 | 35 | 7 | 7/8" | 30.9 |
| 6Y5376 | Dozer End Bit | 504 | 254 | 35 | 7 | 7/8" | 30.9 |
| 6Y5377 | Dozer End Bit | 504 | 254 | 50 | 7 | 7/8" | 43.9 |
| 6Y5378 | Dozer End Bit | 504 | 254 | 50 | 7 | 7/8" | 43.9 |
| 9W1875 | Dozer End Bit | 465 | 254 | 30 | 6 | 3/4" | 25.6 |
| 9W1876 | Dozer End Bit | 465 | 254 | 30 | 6 | 3/4" | 25.6 |
| 9W8874 | Dozer End Bit | 465 | 254 | 25 | 6 | 3/4" | 20 |
| 9W8875 | Dozer End Bit | 465 | 254 | 25 | 6 | 3/4" | 20 |
| 122-8617 | Dozer End Bit | 465 | 254 | 35 | 6 | 3/4" | 27.5 |
| 122-8618 | Dozer End Bit | 465 | 254 | 35 | 6 | 3/4" | 27.5 |
| 3J2465 | Dozer End Bit | 444.5 | 254 | 25 | 7 | 3/4" | 20.9 |
| 3J2466 | Dozer End Bit | 444.5 | 254 | 25 | 7 | 3/4" | 20.9 |
| 4T6667 5J6921 | Dozer End Bit | 419.1 | 254 | 25 | 7 | 3/4" | 17.8 |
| 4T6668 5J6922 | Dozer End Bit | 419.1 | 254 | 25 | 7 | 3/4" | 17.8 |
| 7J2975 | Dozer End Bit | 388.6 | 254 | 40 | 7 | 7/8" | 25.3 |
| 7J2976 | Dozer End Bit | 388.6 | 254 | 40 | 7 | 7/8" | 25.3 |

TEL: +86 574 88220258
FAX: +86 574 88220259
E-mail: xu@china-yasheng.com

Industrial Park,Hengxi Town Yinzhou,Ningbo,Zhejiang,China
All the dimensions in this catalog are subject to our final confirmation
(以上信息均以我司确认为准) 2014-11-22

http: //www.yassian.com

宁波亚升铸业有限公司
Ningbo Yasheng Casting Industry Co.Ltd

| Dozer End Bit | | | | | | | |
|------------------|-----------------|---------------------|--------------------|------------------------|-----------------------|--------------------------|----------------------|
| PART NO. 型号 | PART NAME 品名 | Length 长 (mm) | Width 宽 (mm) | Thickness 厚 (mm) | No. of Holes 孔数 | Bolt Dia 螺栓 (inch) | Weight 重量 (kg) |
| 4T6669 6J8921 | Dozer End Bit | 388.9 | 254 | 25 | 7 | 7/8" | 16.1 |
| 4T6670 6J8922 | Dozer End Bit | 388.9 | 254 | 25 | 7 | 7/8" | 16.1 |
| 4T5407 | Dozer End Bit | 520 | 203 | 25 | 4 | 3/4" | 21.6 |
| 4T5408 | Dozer End Bit | 520 | 203 | 25 | 4 | 3/4" | 21.6 |
| 3G4285 | Dozer End Bit | 425 | 203 | 19 | 4 | 3/4" | 11.6 |
| 9W9014 | Dozer End Bit | 489 | 203 | 25 | 6 | 3/4" | 18.3 |
| 9W9015 | Dozer End Bit | 489 | 203 | 25 | 6 | 3/4" | 18.3 |
| 3G8319 6J0275 | Dozer End Bit | 431 | 203 | 25 | 6 | 3/4" | 16.8 |
| 3G8320 6J0276 | Dozer End Bit | 431 | 203 | 25 | 6 | 3/4" | 16.8 |
| 3G8321 6J0277 | Dozer End Bit | 431 | 203 | 25 | 6 | 5/8" | 16.8 |
| 3G8322 6J0278 | Dozer End Bit | 431 | 203 | 25 | 6 | 5/8" | 16.8 |
| 8E9900 | Dozer End Bit | 441.5 | 203.5 | 25 | 6 | 3/4" | 17.3 |
| 8E9901 | Dozer End Bit | 441.5 | 203.5 | 25 | 6 | 3/4" | 17.3 |
| 4T4435 | Dozer End Bit | 406 | 203 | 25 | 6 | 3/4" | 13.3 |
| 4T4436 | Dozer End Bit | 406 | 203 | 25 | 6 | 3/4" | 13.3 |
| 4T3045 8J7162 | Dozer End Bit | 377.2 | 203 | 19 | 6 | 3/4" | 9.7 |
| 4T3046 8J7163 | Dozer End Bit | 377.2 | 203 | 19 | 6 | 3/4" | 9.7 |
| 5J1419 4J5011 | Dozer End Bit | 374 | 203 | 25 | 6 | 3/4" | 15 |
| 5J1420 4J5012 | Dozer End Bit | 374 | 203 | 25 | 6 | 3/4" | 15 |
| 4T4454 | Dozer End Bit | 430 | 203 | 30 | 6 | 3/4" | 20.1 |
| 4T4455 | Dozer End Bit | 430 | 203 | 30 | 6 | 3/4" | 20.1 |
| 3G8295 6J0893 | Dozer End Bit | 402 | 203 | 25 | 6 | 5/8" | 14.6 |

TEL: +86 574 88220258
FAX: +86 574 88220259
E-mail: xu@china-yasheng.com

Industrial Park, Hengxi Town Yinzhou, Ningbo, Zhejiang, China
All the dimensions in this catalog are subject to our final confirmation
(以上信息均以我司确认为准) 2014-11-22

http: //www.yassian.com

宁波亚升铸业有限公司
Ningbo Yasheng Casting Industry Co.Ltd

| Dozer End Bit | | | | | | | |
|-----------------------|------------------------|----------------------------|---------------------------|-------------------------------|---------------------------|---------------------------------|-----------------------------|
| PART NO. 型号 | PART NAME 品名 | Length 长 (mm) | Width 宽 (mm) | Thickness 厚 (mm) | No. of Holes 孔数 | Bolt Dia 螺栓 (inch) | Weight 重量 (kg) |
| 3G8296 6J0894 | Dozer End Bit | 402 | 203 | 25 | 6 | 5/8" | 14.6 |
| 3G8297 6J0895 | Dozer End Bit | 402 | 203 | 25 | 6 | 3/4" | 14.6 |
| 3G8298 6J0896 | Dozer End Bit | 402 | 203 | 25 | 6 | 3/4" | 14.6 |
| 4T3041 | Dozer End Bit | 378.2 | 203 | 19 | 6 | 3/4" | 10.1 |
| 4T3042 | Dozer End Bit | 378.2 | 203 | 19 | 6 | 3/4" | 10.1 |
| 4T3049 | Dozer End Bit | 368.2 | 203 | 16 | 6 | 5/8" | 9.5 |
| 4T3050 | Dozer End Bit | 368.2 | 203 | 16 | 6 | 5/8" | 9.5 |
| 5R5077 | Dozer End Bit | 344.4 | 203 | 16 | 6 | 5/8" | 7.6 |
| 5R5008 | Dozer End Bit | 344.4 | 203 | 16 | 6 | 5/8" | 7.6 |
| 4T3051 | Dozer End Bit | 344.2 | 203 | 19 | 6 | 5/8" | 8.9 |
| 4T3052 | Dozer End Bit | 344.2 | 203 | 19 | 6 | 5/8" | 8.9 |
| 9F7073 9W9017 | Dozer End Bit | 349.3 | 203 | 16 | 6 | 5/8" | 10.6 |
| 9F7074 9W9016 | Dozer End Bit | 349.3 | 203 | 16 | 6 | 5/8" | 10.6 |
| 4J8261 | Dozer End Bit | 381 | 203 | 19 | 6 | 3/4" | 10.7 |
| 4J8262 | Dozer End Bit | 381 | 203 | 19 | 6 | 3/4" | 10.7 |
| 9F7075 9W9013 | Dozer End Bit | 381 | 203 | 19 | 6 | 5/8" | 10.9 |
| 9F7076 9W9012 | Dozer End Bit | 381 | 203 | 19 | 6 | 5/8" | 10.9 |
| 4T3043 | Dozer End Bit | 289.5 | 203 | 19 | 3 | 5/8" | 7.6 |
| 4T3044 | Dozer End Bit | 289.5 | 203 | 19 | 3 | 5/8" | 7.6 |
| 5A4565 | Dozer End Bit | 301 | 203 | 25 | 3 | 5/8" | 10.8 |
| 5A4566 | Dozer End Bit | 301 | 203 | 25 | 3 | 5/8" | 10.8 |
| 140-6788 | Dozer End Bit | 517 | 204 | 25 | 4 | 3/4" | 20.4 |

TEL: +86 574 88220258
FAX: +86 574 88220259
E-mail: xu@china-yasheng.com

Industrial Park,Hengxi Town Yinzhou,Ningbo,Zhejiang,China
All the dimensions in this catalog are subject to our final confirmation
(以上信息均以我司确认为准) 2014-11-22

http: //www.yassian.com

宁波亚升铸业有限公司
Ningbo Yasheng Casting Industry Co.Ltd

| Dozer End Bit | | | | | | | |
|-----------------------|------------------------|----------------------------|---------------------------|-------------------------------|---------------------------|---------------------------------|-----------------------------|
| PART NO. 型号 | PART NAME 品名 | Length 长 (mm) | Width 宽 (mm) | Thickness 厚 (mm) | No. of Holes 孔数 | Bolt Dia 螺栓 (inch) | Weight 重量 (kg) |
| 140-6787 | Dozer End Bit | 517 | 204 | 25 | 4 | 3/4" | 20.4 |
| 4T6229 8J6412 | Dozer End Bit | 330 | 165 | 16 | 3 | 5/8" | 6 |
| 6Y5840 | Dozer End Bit | 353 | 165 | 16 | 3 | 5/8" | 6.3 |
| 6Y5839 | Dozer End Bit | 353 | 165 | 16 | 3 | 5/8" | 6.3 |
| 8E9378 | Dozer End Bit | 457.2 | 203 | 25 | 4 | 3/4" | 16.2 |
| 8E9379 | Dozer End Bit | 457.2 | 203 | 25 | 4 | 3/4" | 16.2 |
| 5J6941 | Dozer End Bit | 289.5 | 203 | 19 | 3 | 5/8" | 7.6 |
| 5J6942 | Dozer End Bit | 289.5 | 203 | 19 | 3 | 5/8" | 7.6 |
| 3G8299 | Dozer End Bit | 504 | 254 | 30 | 7 | 7/8" | 28.2 |
| 3G8300 | Dozer End Bit | 504 | 254 | 30 | 7 | 7/8" | 28.2 |
| 144-70-11251 | Dozer End Bit | 325 | 222 | 30 | 5 | 3/4" | 16.2 |
| 144-70-11261 | Dozer End Bit | 325 | 222 | 30 | 5 | 3/4" | 16.2 |
| 144-70-11250 | Dozer End Bit | 325 | 222 | 30 | 5 | 3/4" | 16.2 |
| 144-70-11260 | Dozer End Bit | 325 | 222 | 30 | 5 | 3/4" | 16.2 |
| 150-70-21346 | Dozer End Bit | 435 | 254 | 30 | 6 | 3/4" | 25 |
| 150-70-21356 | Dozer End Bit | 435 | 254 | 30 | 6 | 3/4" | 25 |
| 140-70-11170 | Dozer End Bit | 359 | 222 | 25 | 5 | 3/4" | 14.7 |
| 140-70-11180 | Dozer End Bit | 359 | 222 | 25 | 5 | 3/4" | 14.7 |
| 17M-71-21930 | Dozer End Bit | 692 | 315 | 40 | 7 | 1" | 67 |
| 17M-71-21940 | Dozer End Bit | 692 | 315 | 40 | 7 | 1" | 67 |
| 195-71-11173 | Dozer End Bit | 680 | 330 | 40 | 7 | 1" | 62.6 |
| 195-71-11183 | Dozer End Bit | 680 | 330 | 40 | 7 | 1" | 62.6 |

TEL: +86 574 88220258
FAX: +86 574 88220259
E-mail: xu@china-yasheng.com

Industrial Park, Hengxi Town, Yinzhou, Ningbo, Zhejiang, China
All the dimensions in this catalog are subject to our final confirmation
(以上信息均以我司确认为准) 2014-11-22

http: //www.yassian.com

宁波亚升铸业有限公司
Ningbo Yasheng Casting Industry Co.Ltd

| Dozer End Bit | | | | | | | |
|-----------------------|------------------------|----------------------------|---------------------------|-------------------------------|---------------------------|---------------------------------|-----------------------------|
| PART NO. 型号 | PART NAME 品名 | Length 长 (mm) | Width 宽 (mm) | Thickness 厚 (mm) | No. of Holes 孔数 | Bolt Dia 螺栓 (inch) | Weight 重量 (kg) |
| 195-71-51630 | Dozer End Bit | 622 | 330 | 40 | 7 | 1" | 60 |
| 195-71-51640 | Dozer End Bit | 622 | 330 | 40 | 7 | 1" | 60 |
| 175-71-22271 | Dozer End Bit | 630 | 254 | 35 | 7 | 7/8" | 42.1 |
| 175-71-22281 | Dozer End Bit | 630 | 254 | 35 | 7 | 7/8" | 42.1 |
| 175-70-21126 | Dozer End Bit | 492 | 254 | 35 | 7 | 7/8" | 32.2 |
| 175-70-21136 | Dozer End Bit | 492 | 254 | 35 | 7 | 7/8" | 32.2 |
| 175-71-22272 | Dozer End Bit | 540 | 254 | 40 | 7 | 7/8" | 39.6 |
| 175-71-22282 | Dozer End Bit | 540 | 254 | 40 | 7 | 7/8" | 39.6 |
| 195-71-61930 | Dozer End Bit | 765 | 393 | 50 | 8 | 1-1/4" | 111 |
| 195-71-61940 | Dozer End Bit | 765 | 393 | 50 | 8 | 1-1/4" | 111 |
| 14X-71-11330 | Dozer End Bit | 330 | 203 | 25 | 5 | 3/4" | 12.2 |
| 14X-71-11340 | Dozer End Bit | 330 | 203 | 25 | 5 | 3/4" | 12.2 |
| 144-70-11180 | Dozer End Bit | 330 | 222 | 25 | 5 | 3/4" | 14.7 |
| 144-70-11190 | Dozer End Bit | 330 | 222 | 25 | 5 | 3/4" | 14.7 |
| 12F-929-2170 | Dozer End Bit | 318 | 152 | 16 | 4 | 1/2" | 5.3 |
| 120-70-31411 | Dozer End Bit | 375 | 203 | 25 | 4 | 5/8" | 13.7 |
| 198-71-31520 | Dozer End Bit | 760 | 393 | 60 | 8 | 1-1/4" | 131 |
| 198-71-31530 | Dozer End Bit | 760 | 393 | 60 | 8 | 1-1/4" | 131 |
| T223519 | Dozer End Bit | 346 | 203 | 19 | 6 | 3/4" | 8.7 |
| T223520 | Dozer End Bit | 346 | 203 | 19 | 6 | 3/4" | 8.7 |
| T204080 | Dozer End Bit | 482.6 | 203 | 19 | 6 | 3/4" | 12 |
| T204081 | Dozer End Bit | 482.6 | 203 | 19 | 6 | 3/4" | 12 |

TEL: +86 574 88220258
FAX: +86 574 88220259
E-mail: xu@china-yasheng.com

Industrial Park,Hengxi Town Yinzhou,Ningbo,Zhejiang,China
All the dimensions in this catalog are subject to our final confirmation
(以上信息均以我司确认为准) 2014-11-22
<http://www.yassian.com>

宁波亚升铸业有限公司
Ningbo Yasheng Casting Industry Co.Ltd

| Dozer End Bit | | | | | | | |
|-----------------------|------------------------|----------------------------|---------------------------|-------------------------------|---------------------------|---------------------------------|-----------------------------|
| PART NO. 型号 | PART NAME 品名 | Length 长 (mm) | Width 宽 (mm) | Thickness 厚 (mm) | No. of Holes 孔数 | Bolt Dia 螺栓 (inch) | Weight 重量 (kg) |
| U13733 | Dozer End Bit | 647 | 390 | 50 | 7 | 1" | 80.9 |
| U13734 | Dozer End Bit | 647 | 390 | 50 | 7 | 1" | 80.9 |
| U11100 | Dozer End Bit | 541 | 253 | 40 | 7 | 7/8" | 42.3 |
| U11101 | Dozer End Bit | 541 | 253 | 40 | 7 | 7/8" | 42.3 |
| T101639 | Dozer End Bit | 355.6 | 206 | 25 | 3 | 3/4" | 13.5 |
| T167829-138 | Dozer End Bit | 487 | 233 | 35 | 3 | 1" | 28 |
| AT139622 | Dozer End Bit | 558.8 | 241 | 40 | 3 | 1-1/4" | 39.5 |

TEL: +86 574 88220258
FAX: +86 574 88220259
E-mail: xu@china-yasheng.com

Industrial Park,Hengxi Town Yinzhou,Ningbo,Zhejiang,China
All the dimensions in this catalog are subject to our final confirmation
(以上信息均以我司确认为准) 2014-11-22

http: //www.yassian.com